

LENOXX

Model no: RC1577

Batch no: PR3758

USER'S GUIDE

For your quicker and more comfortable operation.

Longitudinal remote control car, please read the instructions before use.

Packaging and instructions contain important information, Should be retained.

1 BATTERY INSTALLATION:

1. The remote control uses four 1.5V "AA" non-rechargeable batteries (sold separately), and mount them in the bottom of the remote control in the correct polarity.
Close the battery cover and tighten the screw (Figure A).
2. Remote control car Use the 7.2V rechargeable battery pack (included with the battery) to connect in the correct way. Close the battery cover and tighten the screw (Figure B).

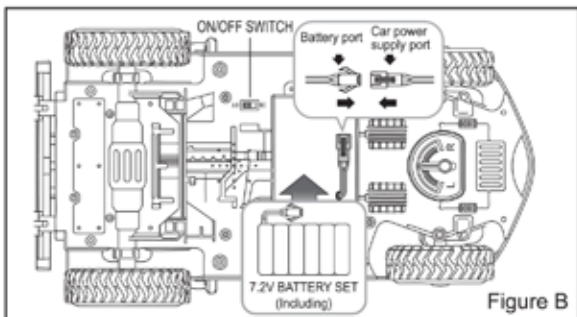
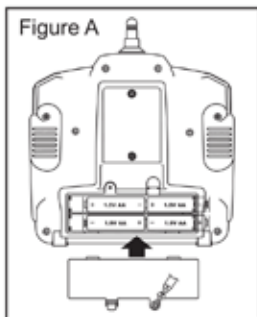

2 RECHARGEABLE BATTERY NOTE:

1. To charge the battery pack, the need for adult monitoring.
2. Non-rechargeable battery can not be charged; different types of batteries or old and new batteries can not be mixed.
3. Recharge the battery pack before removing the battery.
4. Connect the USB charging cable to the rechargeable battery pack connector.
5. When the battery is fully charged, unplug the USB cable, and then gently separate it from the USB charging cable.
6. When not using the remote control car for a long time, please remove the battery.
7. USB charging cable in the course of its regular inspection of its wires, plugs, crust and other parts are damaged, found damaged should stop using until the repair intact.
8. When the remote control car battery is low, may lead to decreased performance, please recharge the battery in time, or replace the battery can play.
9. To be equipped with rated USB cable input current charge.
10. Battery in the process of using and charging the battery surface temperature rise is normal.

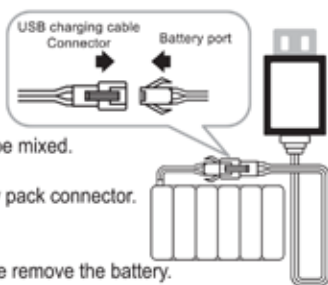

3 BATTERY CHARGING METHOD:

USB charging is roughly divided into
Three charging modes:



Mode 1
connect to the computer
USB charging



Mode 2
Connect the USB
adapter charge



Mode 3
charging a mobile
charging treasure

CHARGING PROCESS:

1. When the connection LED lights; 2. Charge when the LED lights slowly flashing; 3. When the LED lights out; (When the USB charging head LED light is flashing, the charging fails. Please check the circuit and re-operate the charging procedure.)

NOTE: The first charge time of 8 hours, 4-5 hours after each charge (improper charging will affect the battery life).

4 FREQUENCY MATCHING

This product uses 2.4GHz frequency remote control, before playing,
Should be on the remote control and car frequency matching;

1. First remote control car and remote control, Turn the power on after installing the battery.

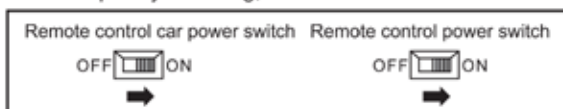

2. At this time the remote control will automatically find the frequency, the indicator light flashes. When the remote control indicator stops flashing, The car will issue a "beep" sound, frequency matching is complete, remote control function can be used normally. (If the frequency matching fails, please power off the remote control car and remote control, and then re-operation of the above steps.)

5 THE MAIN PARAMETERS







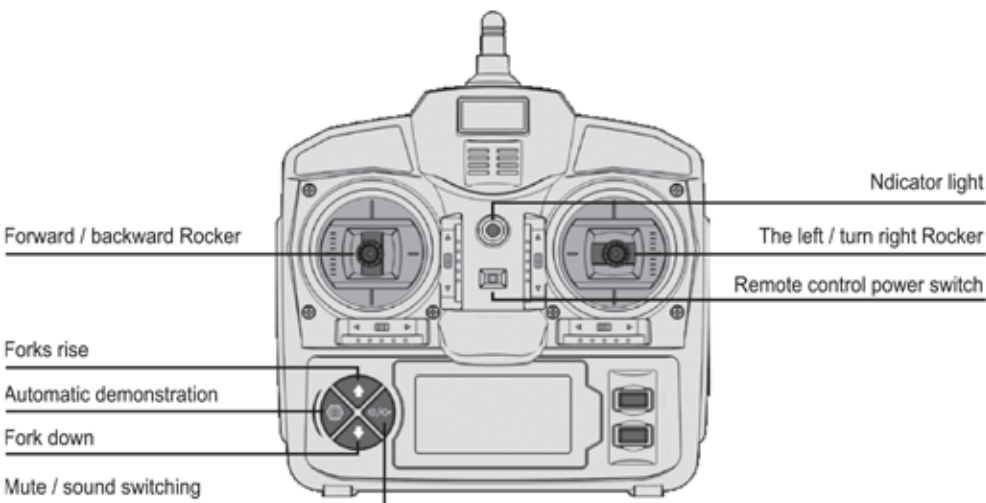







Product number: 1577 Material composition: plastic and electronic components

Battery: Body Battery: 1X7.2V rechargeable battery pack,

Remote control Battery: 4X1.5V "AA" non-rechargeable battery.



6 FUNCTION AND OPERATING INSTRUCTIONS:

1. Forward		
2. Backward		
3. Turn left		
4. Turn right		
5. Fork lift		
6. fork down		
7. Automatic demonstration Function starts		

①. Press the Auto Demo button:
Forklift presentation forward, back, turn left, right turn, fork up, fork movements and other movements;
②. Press any key to cancel the demonstration mode;

7 FORK / HOOK INSTALLATION AND REPLACEMENT INSTRUCTIONS:

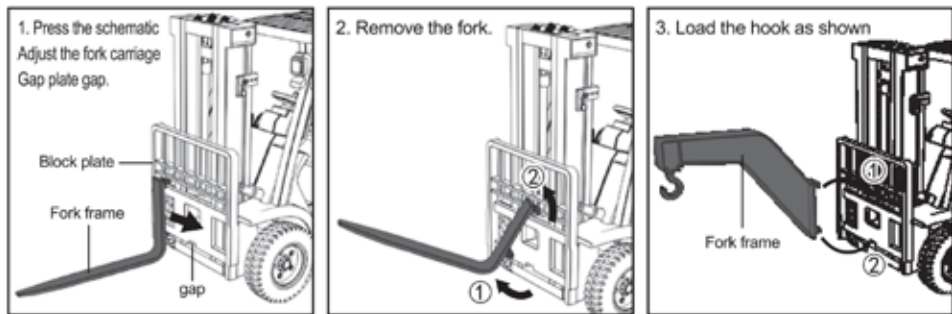

8 ON THE REMOTE CONTROL CAR DIRECTION ADJUSTMENT:

When the remote control car can not take a straight line, adjust the bottom of the car pointer, dial to the "left" or "right" to amend.



PRECAUTIONS

1. Do not play in the road, crowded places and high-voltage wires to play the toy, to avoid danger.
2. Water in the play may cause damage to the circuit short circuit, use a dry cloth to wipe the surface stains.
3. Operation speed significantly slowed down during the operation may be insufficient power, please charge in time.
4. Non-rechargeable batteries can not be charged. When charging the rechargeable battery, you need adult monitoring. The charger is not a toy. Please charge it using our recommended charger.
5. When installing the battery polarity must be correct.
6. Do not mix new and old or different types of batteries, battery terminals should not be short-circuit.
7. The battery charger should periodically check its plug, housing and other parts are damaged, found damaged should stop using.
8. This product can not be connected to a power supply with different performance specifications.
9. Antenna can not be plugged into the power outlet, so as to avoid danger.

Warning: Choking hazard - This product may contain small parts, Not suitable for children under three years of age.

www.lenoxx.com.au



1300 666 848