

**LENOXX**  
PDVD1500

# 15.4" SWIVEL PORTABLE DVD PLAYER

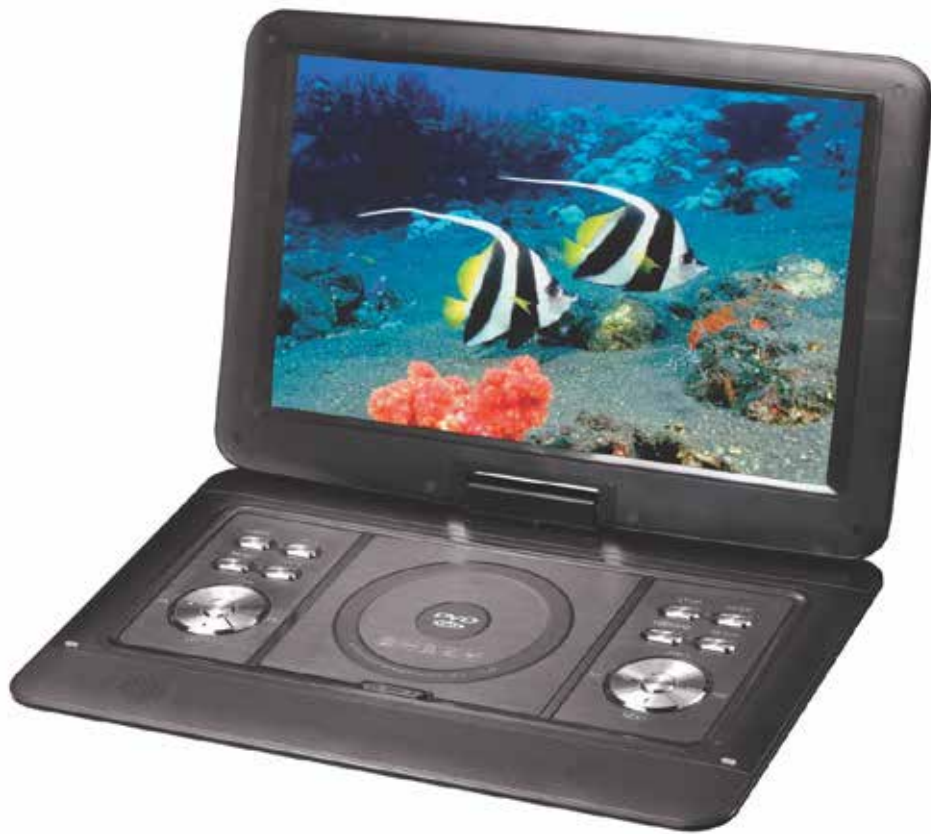

**MODEL NO: PDVD1500**

**BATCH NO: PR4089**

## **INSTRUCTION MANUAL**

Please read and retain this info for future reference.

**Features:**

- Lightweight, Compact & Portable
- Hi-Res HD Widescreen Display
- Top-Loading CD/DVD Tray
- Built-in Rechargeable Battery
- Dual Full Range Stereo Speakers
- USB Flash & SD Memory Card Readers
- Versatile Digital Media File Compatibility
- Audio, Image & Video File Support
- Swivel Angle Adjustable Display Screen
- Top Panel Button Controls
- Speaker: 3W (2 X 1.5W)
- Headphone Jack, 3.5mm
- Copy MP3 files from a CD to USB stick
- Display Type: 15.4" -inch LCD (16:10)
- Monitor Rotation: 270 Degree Left/Right
- Battery: 2500mAh, Li-thium battery 7.4V
- Battery playback time after full charge: 2 hours
- Battery re-charge time: 5 – 6 Hours
- Resolution size pixels: 1280 x 800
- Frequency Response: 20-20kHz
- Dynamic Range: >85dB
- T.H.D.: <1.0%
- CD/DVD Compatibility Type: VCD, CD-RW, DVD-R
- Digital Media File Support: AVI, MP3, WMA, JPG, VCD, EVD, VOB
- Maximum USB/SD Flash Memory Support: Up to 32GB
- Power: 100/240V (12V DC Power Adapter)

## IMPORTANT SAFETY INSTRUCTIONS AND PRECAUTIONS

### Warning:

TO REDUCE THE RISK OF FIRE OR ELECTRIC SHOCK, DO NOT EXPOSE TO MOISTURE. DO NOT REMOVE COVER (OR BACK). NO USER-SERVICEABLE PARTS INSIDE. REFER SERVICING TO QUALIFIED SERVICE PERSONNEL. SERVICE MUST BE CARRIED OUT BY QUALIFIED PERSONNEL ONLY, OR THE WARRANTY IS NOT VALID.



 The lightning flash with arrowhead symbol, within an equilateral triangle, is intended to alert the user to the presence of non-insulated dangerous voltage within the product. This may be of sufficient magnitude to constitute a risk of electric shock to persons.

 The exclamation point within an equilateral triangle is intended to alert user to the presence of important operating procedures and maintenance (service) instructions in the literature accompanying the appliance.



**Laser product symbol:** located on the rear panel of the unit (in some cases at the bottom side), indicates that this player is a class 1 laser product, it uses only weak laser and no hazardous radiation outside of the unit.

### Installation

Ensure that the portable DVD player is installed in accordance with the instructions and illustrations provided in this manual.

## General Precautions

- 1) Read through this instruction manual before installation and use.
- 2) Do not touch the power plug with wet hand.
- 3) Switch off the main power when the unit is not in use. (Disconnect the power plug from the power outlet when you do not intend to use the unit for a longer period of time.)
- 4) Do not open the cover or touch any of the components inside the unit, only for qualified technicians.
- 5) Do not expose the unit to direct sunlight or nearby objects that radiate heat to avoid damage to the unit.
- 6) Do not place the unit in moist and humid environments.
- 7) Please ensure the ventilation holes are not covered to avoid overheating and malfunction.
- 8) Clean the panel and case with soft dry cloth only, do not apply any kind of thinner, alcohol or sprays.
- 9) The apparatus shall not be exposed to dripping or splashing, nor should any objects filled with liquids, such as vases, be placed on the apparatus.

## Clean the Machine

- 1) Please ensure the machine is power off before cleaning.
- 2) Do not use any chemicals or cleaning agents to clean the machine.
- 3) Use slightly damp cloth to clean the outside of the machine.

## Do not Open

To reduce the risk of Electric Shock, Do not remove cover (or back). No user-serviceable parts inside. Refer servicing to qualified service personnel.

## Care of Disc

- 1) Do not place disks near heat sources such as direct sunlight or high humidity areas.
- 2) Stack disks on top of each other, in the same way.
- 3) Do not touch the disk surface, hold the disc by the edges.
- 4) Do not use adhesive tape on the disk surface.
- 5) Wipe the disk from inside to outside with a soft cloth.
- 6) Do not use gasoline, non-disc special or antistatic cleaning agents to clean the disc because these substances will cause damage.



## **WHATS IN THE BOX**

1 x Main DVD player with 15.4" LCD screen	1 x Remote control (batteries not included, requires 2 x AAA batteries)
1 x 12V DC car charger	1 x 240V AC power adapter
1 x AV lead	1 x Instruction manual
1x Warranty card	

***Please check the contents of the packaging carefully.***

## **INSTALLATION**

### **Indoor Use**

1. Locate a spare mains outlet and turn it OFF.
2. Plug the supplied AC adaptor into the outlet.
3. Connect the other end to the SC9-12V/2A DC power input socket on the side of the DVD player.
4. Turn the main outlet ON.
5. Turn the main Power Switch on the Player to the ON position.

### **In-car Use**

1. With the vehicle ignition off, connect the supplied car charger to the vehicle power outlet.
2. Connect the other end to the SC9-12V/2A DC power input on the side of the DVD player.
3. Turn the vehicle ignition to ON or ACC to power the outlet and slide the DVD player power switch to the ON position.

***Note: Care should be taken with all cable and connections with the DVD player. Please ensure that there is no tension on any connection as this may damage the units. Tidy any excess cabling to trip hazards that may damage the player.***

## **PLAYBACK**

**Panel:**

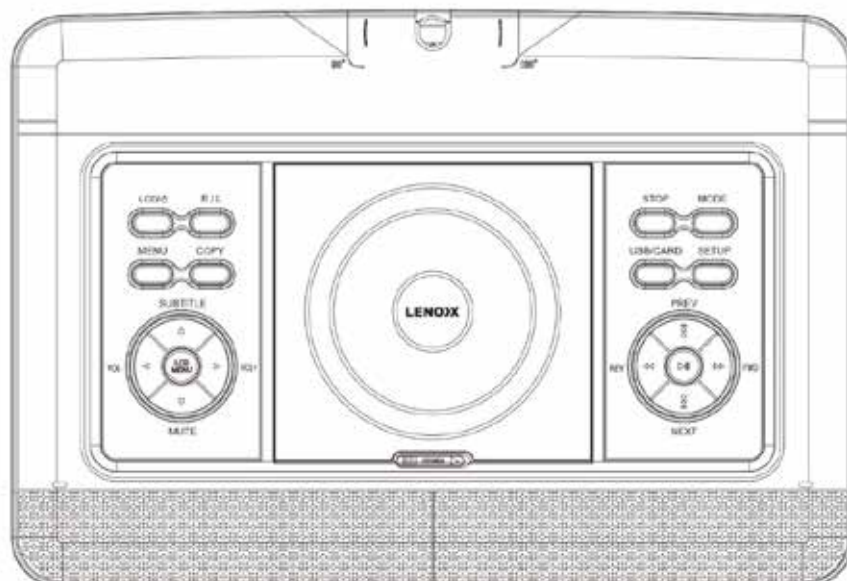

<b>BUTTON</b>	<b>FUNCTION</b>
LCD POWER	Press to turn the screen display on or off
R/L	Press to change between right and left channel audio
MENU	Press to access a DVD discs menu on discs which allow this function
COPY	For use with the copy from CD disc to flash stick function
VOL-	Press to decrease volume
SUBTITLE	Press to access subtitles on discs which allow for this function
VOL+	Press to increase volume
MUTE	Press to mute sound/un-mute sound
STOP	Press to stop playback
MODE	Press to change playback mode
USB/CARD	When in disc playback, press to change from disc play mode to USB/SD mode
SETUP	Press to access the set up menu for the DVD player
REV	Press to rewind in DVD playback. Press to go back a song in CD playback
PREV	Press to fast forward in DVD playback. Press to go forward a song in CD playback
FWD	Press to go back a chapter when playing a DVD disc which allows for this function
NEXT	Press to go forward a chapter when playing a DVD disc which allows for this function
	Press to pause playback, press again to resume playback
OPEN	Switch to open lid for DVD player

**Side Panel:**

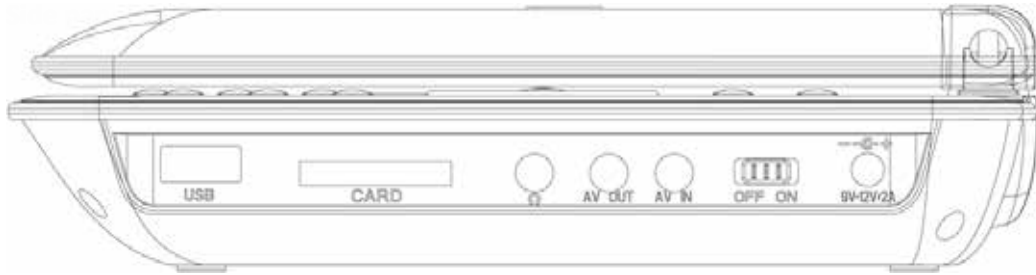

ITEM	FUNCTION
USB	USB port
SD/MMC	SD/MMC Card socket
Ω EARPHONE	Connect earphones to this jack, earphones not included
AV OUT	Video out signal
AV IN	External video input signal
VOL+	Press to increase volume
OFF/ON	OFF/ON switch to turn the player off and on
SC9-12V/2A DC power in socket	Socket for connection to mains adaptor or car adaptor

**The Remote Control**



BUTTON	FUNCTION
POWER	Press to put the unit in standby mode, press again to take it off standby mode
CARD/USB	Press to change the playback method from memory card or USB
ZOOM	When playing a DVD disc, press repeatedly to zoom in or zoom out
MUTE	Press to mute sound un-mute sound
PROG	N/A for this model
COPY	For use with the function, copy MP3 files from a CD disc to USB stick
OSD	Press to display disc info when playing a DVD/CD disc
REPEAT	Press to repeat current playing music track
SETUP	Press to enter set up menu's for the DVD player
MODE	Press to change playback mode
◀	◀ Directional button – left. For use in menus
▲	▲ Directional button – up. For use in menus
▶	▶ Directional button – right. For use in menus
▼	▼ Directional button – down. For use on menus
ENTER	Confirmation button for use when using the set up menus
MENU	Press to access the menu for DVD discs which allow for menu selection
■ STOP	Press to stop playback
VOL -	Press to decrease volume
▶    PLAY/PAUSE	Press to pause playback. Press to resume playback
VOL +	Press to increase volume
◀◀	Press to rewind in DVD playback. Press to go back a song in CD playback.
▶▶	Press to fast forward in DVD playback. Press to go forward a song in CD playback.
◀◀	Press to go back a chapter when playing a DVD disc which allows for this function
▶▶	Press to go forward a chapter when playing a DVD disc which allows for this function



LCD MENU	Press to access the LCD settings menu
SUBTITLE	Press to access subtitles on discs which allow for this function
AUDIO	Press to switch between left/right/stereo sound playback
GOTO	Press to jump to a particular section when playing a DVD disc that allows for this function
RETURN	Exits current operation, e.g.: menu
NUMBER KEYS	Press during CD disc playback to jump to a particular track

### Batteries in the remote control

1. Remove the battery cover from the rear of the remote control.
2. Add 2 x AAA batteries (not included) to the remote as per the polarity directions in the battery compartment in the remote control.
3. Put the battery cover back onto the rear of the remote control.

#### Note:

1. Do not use re-chargeable batteries in the remote control, because they lose power at a slower rate.
2. Do not mix different brands and type of batteries, do not use old and new batteries together.
3. When the remote control function is not strong or control range is small, replace the batteries.
4. If the remote control will not be used for a long time, remove the batteries to avoid damage to the remote control from battery leakage or corrosion.
5. Do not use the remote control in hot or humid conditions.
6. Do not disassemble the remote control.

### Basic Function Operation

#### 1. Operation

Connect either the 240V mains power adaptor (indoor use) or the 12V car adaptor (in car use) to the DC input socket on the DVD player.

Switch the ON button on the machine to turn on the DVD player.

Turn the switch to OFF when not in use.

#### 2. Place disc

- 1) Press OPEN to open the disc cover.
- 2) Hold the edge of the disc insert the disc.
- 3) Close the disc cover.

#### 3. Play /Pause

- 1) This player will automatically play once the disc is loaded.
- 2) Press ►|| to pause
- 3) Press ►|| once more to resume play.

#### 4. Play back from USB/SD/MMC memory card

Press the SD/USB button to play back from USB or memory card.

## **5. TFT picture adjustment**

Press LCD MENU to access the LCD setup menu for adjustment.

Use the directional arrow buttons on the remote control to select the desired submenu function and use the left or right arrows to adjust the function.

- 1) BRIGHTNESS
- 2) CONTRAST
- 3) COLOUR
- 4) TINT
- 5) RATIO
- 6) DEFAULT – if this option is selected, the function setting is restored back to the factory settings.

## **6. Character display**

Press OSD to show disc information and operation function and press OSD once again to turn off the display.

## **7. DVD disc menu play**

Some DVD discs are recorded with title menu or chapter menu.

When MENU button on the remote controller is pressed, the screen will display the menu at your choice. Press direction buttons to adjust and press ENTER to confirm and press number buttons to select. Press MENU button again to return root menu. Press TITLE button once again to return title menu.

## **8. Select chapter play direct by number button**

Press number buttons to directly select the chapter to play once the player finished the disc reading.

- 1) Press number buttons 1-9 for the chapters with the number less than 10.
- 2) For the chapters with the number above 10, press 10+ button (it switches to 20+, 30+...when pressed in succession) , before pressing number button 0-9

## **9. DVD Menu Setup**

### **1) System Setup Page**

a. Screen Display: NTSC & PAL & AUTO

b. Last Memory State: When the DVD player is powered off, the system can resume playback from its last position when the DVD player is turned on again. The options are ON or OFF.

c. Screen Saver: The options are ON or OFF.

d. Display Type: The options are:

4:3 PS: When a wider screen video is played, the left and right edges of the video will be cut off.

4:3 LB: When a wider screen video is played, the top and bottom of the screen will have black strips.

16:9: Suitable for a wide screen display

Note: the play effect is related to the ratio of the video recorded. Therefore, some videos may not be played in the screen size you have chosen.

e. Password: works with classification disc.

The default password for this model is 0000.

Initially, this option is set as 'password lock.

To revise the password, the old password must be entered and then a new password can be added by using the numerical keys. The new password must be 4 digits in length.

f. Rating (Age limit). For use with a disc which allows for this function. You can choose an age control level. The options you can choose from are:

1. Kid Safe.
2. G.

- 3. Pg
- 4. Pg 13
- 5. Pg-R
- 6. R
- 7. NC 17
- 8. Adult

This function is only suitable for a disc with the level limit system. This function will only work when the password function has been released.

g. Default Value: Factory Reset. When this is chosen

## 2) Language Setup

- a. OSD Language: English, Chinese, French, German, Spanish, Italian, Portuguese, Russian,
  - b. Audio Language: English, Chinese, French, German, Spanish, Italian, Portuguese, Russian,
  - c. Subtitle Language: English, Chinese, French, German, Spanish, Italian, Portuguese, Russian,
  - d. Menu Language: English, Chinese, French, German, Spanish, Italian, Portuguese, Russian,
- note: If a language you have chosen is un-available in the DVD, then this device will automatically choose the defaulted language of the disc.

## 3) Audio Setup

Press the up and down arrow buttons to move the slider to adjust the audio:

+4,+2,0,-2,-4,b

## 4) Video Setup

Press the up and down arrow buttons to adjust setup of:

- a. brightness
- b. contrast ratio
- c. hue
- d. saturation
- e. sharpness

## 5) Digital Setup:

Press the arrow buttons to adjust setup of:

- a. OP mode: Line Out & RF
- b. Dynamic Range: Full 6/8, 4/8, 2/8, off
- c. Dual mono: Stereo Mono L, Mono R, Mix Mon

## Disc Play

### 1. Audio Track Selection

1) You may select the required language when playing DVD or super VCD discs with multi languages

During the play of DVD and super VCD, press AUDIO to choose the language (depends on the discs)

2) You may select mono L, mono R or stereo for the CD or VCD with multi audio tracks.

### 2. Fast play

During the play of discs, you can use fast forward or rewind to search specific target.

Press ◀◀ enter into fast rewind status. Every press of ◀◀ will adjust the rewind speed.

FRX2 → FRX4 → FRX8 → FRX16 → FRX32 → Play Press ▶▶ for normal play

2) Press ▶▶ enter into fast forward status. Every press of ▶▶ will adjust the forward speed.

FF X2 → FFX4 → FFX8 → FFX16 → FFX32 → Play Press ► || for normal play

### 3. Repeat Play

You can select title repeat and chapter repeat during the play of DVD discs.

1) Chapter repeat:

Press REPEAT till the screen displays "REPEAT CHAPTER"

2) Title Repeat:

Press REPEAT till the screen displays REPEAT TITLE

3) Cancel Repeat:

Press REPEAT till the screen displays REPEAT OFF

You can select single repeat and disc repeat during the play a CD disc.

1) Repeat One

Press REPEAT till the screen displays "REPEAT ONE ",

2) Disc Repeat

Press REPEAT till the screen displays "DISC REPEAT"

3) Cancel Repeat

Press REPEAT TILL the screen display disappears

### 4. Subtitle Selection

You may select one subtitle to be display for the DVD disc playback with multi language

1) Press SUBTITLE to select one subtitle display

2) Cancel subtitle display: press SUBTITLE till the screen displays OFF

Note: Subtitle function depends on the discs. If the subtitle on the discs is non-selectable, then it is void to press SUBTITLE

### 5. Chapter search, Time search

Press GOTO during disc play and press direction keys to select among the following options:

1) Title: To display current title. You can input the title number to be played.

2) Chapter: To display current playing chapter. You can input the chapter number to be played.

3) Time: To display the current playing time. You can input the time to be played

After choosing, press ENTER and exit the menu.

### 6. Zoom Function (Only effective for DVD, SVCD, VCD)

To zoom in or zoom out the certain motion pictures or still image

1) During disc play, press ZOOM to zoom into 2x.

2) Press ZOOM in turn to zoom into 3x. 4x and zoom out 1/2x. 1/3x and 1/4x.

3) When resuming to the original image, press ZOOM until the zoom disappears.

### 7. MP3 Disc Play

1) Place the disc into the DVD player. The screen will display the disc menu and the machine automatically play.

2) Directory selection; Press ◀ to move the cursor to the directory area (the left side of the screen) . Press ▲ or ▼ to select one folder and press ENTER to confirm

3) Chapter Selection: Press ◀ to move the cursor to chapter area (the right side of the screen) . Press ▲ or ▼ to select one folder and press ENTER to play

4) Choose the chapter with remote control: If the song quantity is under 10, you can choose directly with the numerical buttons on the remote control.

## CD copying to USB flash stick

When playing a CD/MP3 disc, insert a USB flash stick to the USB port on the DVD player, press the COPY button.

Press the up/down buttons on the remote control to move the cursor to TRACKS.

Press the right arrow button on the remote control to move the cursor to the TRK TITLE menu.

Press the enter button on the remote control to choose all tracks.

Press the up/down buttons on the remote control to move the cursor to the track to be reproduced and press the enter button to confirm.

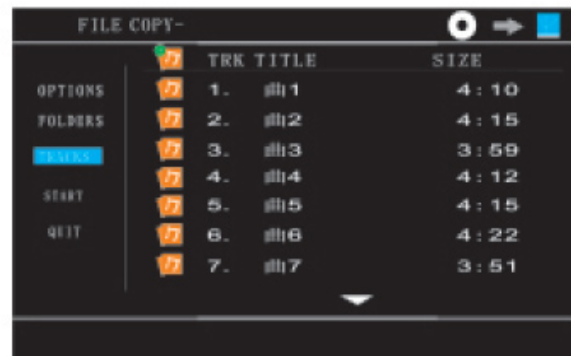

Press the enter button on the remote control to choose the desired music track, press the arrow buttons on the remote control to move the cursor to the START option and then press the enter button to start copying.

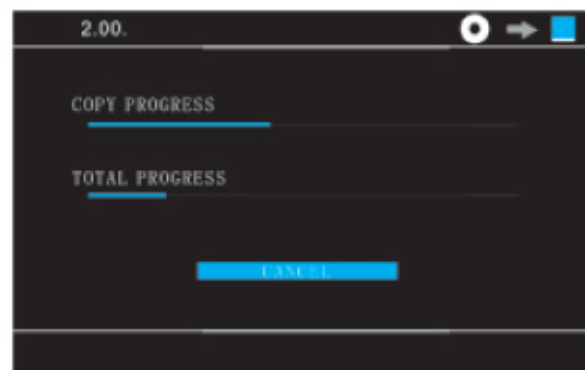
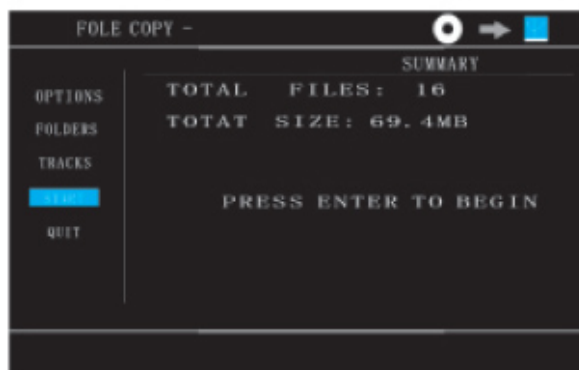

During the copying process, do not remove the USB stick from the DVD player or power the DVD player off.

When the music file to be copied has played in full, the copying process will be complete at the same time. When the copying process has been completed, use the arrow buttons on the remote control to move the cursor to the QUIT option. Press the ENTER button on the remote control to exit and then remove the USB stick from the DVD player.

## AV OUT (Signal to TV)

To connect the DVD player with a TV set, ensure the channel selected to view on the TV screen is the correct AV channel relating to the AV ports that the DVD player has been connected to.

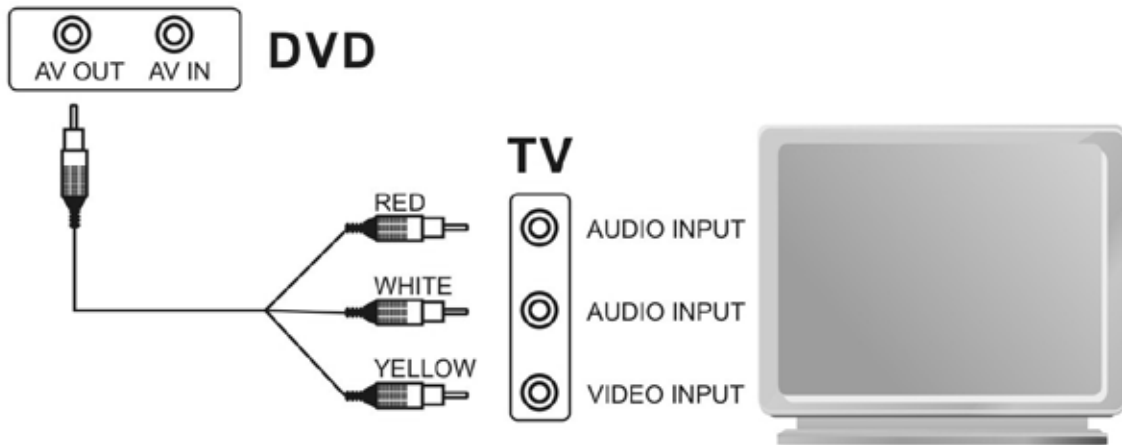

## Troubleshooting

Fault	Solution
No power/no charging	Check that the adaptor is connected Check that the DVD player is ON
No disc	Check that disc has been placed in the DVD player correctly If the disc is damaged or dirty change to a different disc Ensure the disc is of a compatible format to be played in the DVD player
No pictures	When connected to a TV set using the AV ports, check the TV is turned on Check that the DVD player is turned on
Can not choose song	Remote is damaged Check batteries are inside the remote Ensure the batteries are not flat
No Audio	Check that the volume is not on silent Check that the sound is not on mute There is no sound when in Pause, fast forward, fast rewind modes.

## DVD Specification

Compatible disc	DVD, SVCD, VCD, CD, CD-R/RW, JPEG, DVD-R/RW, WMA, AVI, MP3.
Supporting out device	USB/MMC/SD
Anti-shock function	DVD; 3 seconds; VCD/CD; 10seconds; MP3; 90seconds
Audio out	AUDIO; 2. 0V+-0. 2, Speak: 8Ω/1. 5W; Output of earphone: 15mW
Frequency	20HZ—20KHZ
Audio (S/N) Radio	≥50dB
Range of activity	≥50dB
Video output	1. 0V±0. 2Vp-p(75Ω)
Video output	PAL/NTSC/AUTO

**LENOXX**

[www.lenoxx.com.au](http://www.lenoxx.com.au)

 1300 666 848

 LenoxxElectronics  @LenoxxAustralia