

LENOXX
PDVD830

9" TWIN SCREEN PORTABLE DVD PLAYER



Model no: PDVD830.

Batch no: PR3959

INSTRUCTION MANUAL

PLEASE READ AND RETAIN INSTRUCTIONS FOR FUTURE REFERENCE.

Table of Contents

SAFETY PRECAUTIONS	3
Warning.....	3
Safety Precautions.....	3
Power supply.....	4
Operation and position.....	4
Service and maintenance.....	4
Cleaning and care.....	5
PACKAGE CONTENTS	5
OPTICAL DISCS	6
CONNECTIONS	7
Before connecting.....	7
Connecting external TV/Monitor.....	7
How to use the headrest mount.....	8
How to use the stand of the main unit.....	9
Connecting headphones.....	9
Connecting power supply.....	10
FUNCTIONAL OVERVIEW	11
DVD Player View.....	11
REMOTE CONTROL	12
BASIC OPERATION	13
Disc error messages.....	14
Playable discs.....	14
Turn on/off the player.....	14
Selecting different modes (DVD/USB/CARD).....	14
Playing discs.....	14
Using the disc menu.....	15
Return to the root menu or title menu.....	15
Play/Pause the playback (DVD/VCD/CD/MP3).....	15
Volume control.....	15
Selecting a track/ chapter/ title (DVD/ VCD/ CD).....	15
Stop playback (DVD/ VCD/ CD).....	15
Fast forward / Fast backward searching (DVD/ VCD/ CD/ MP3).....	15
Slow Motion Playback (DVD, SVCD, VCD).....	15
Repeat A-B (DVD/ VCD/ CD/ MP3) playback.....	15
Repeat playback (DVD/VCD/CD/ MP3/Xvid disc).....	16
Program playback.....	16
Zoom (DVD/ VCD).....	16
Selecting subtitle languages (DVD).....	16
Changing the audio soundtrack languages (DVD).....	16
Changing the audio channel (CD/MP3/VCD).....	16
Information display.....	16
Numeric buttons.....	17
Using the search feature(DVD/VCD/CD).....	17
SPECIAL FEATURES	17
MP3/WMA/AVI Playback.....	17
Photo/picture CD playback.....	18
Connect to USB.....	18
Connect to SD/MMC Memory Card.....	18
SYSTEM SETUP	19
General.....	19
Speaker.....	19
Dolby digital.....	20
Panel quality.....	20
Preference.....	20
Panel quality for the monitor unit.....	21
TROUBLESHOOTING	22
SPECIFICATIONS	23

SAFETY PRECAUTIONS

Warning

To prevent fire or shock hazard, DO NOT expose this appliance to rain or moisture.

High Voltage Warning

Dangerous high voltages are present inside this enclosure. To avoid electric shock, DO NOT open the unit; refer servicing to qualified personnel only.

Laser

This player is classified as a CLASS 1 laser product To prevent direct exposure to the laser beam, do not try to open the DVD player.

Do not attempt to dismantle the player. You may become exposed to invisible laser radiation if the product is open or the interlock is tampered. Avoid direct exposure to beam.

Instruction Manual

1. To ensure the proper operation, all the safety and operating instructions should be read carefully before connection and operation.
2. Retain instructions - Keep this manual in a safe place for further reference .
3. All warnings on the product and in the instruction manual should be adhered to.
4. All operating and use instructions should be followed.

Safety Precautions

1. The DVD player is intended for household use only, and not for commercial or industrial use.
2. This DVD player shall not be exposed to dripping or splashing water and no object filled with liquids such as vases shall be placed on the appliance. Dry location use only.
3. Do not expose the appliance, discs to extreme temperatures, excessive moisture, rain or sand. Never use this device in high temperature or in high humidity. The best operating temperature is between 5°C~40°C.
4. No open flame sources such as lighted candles should be placed on the appliance.
5. Do not place the unit on unstable surface to prevent from falling. Do not place the unit on top of any other appliance.
6. Do not place the appliance on or near a hot gas flame, electric element, and heaters or in areas subjected to direct sunlight.
7. Place the appliance where there is good air ventilation. Any ventilation holes should not be impeded by covering with items, such as newspaper, tablecloths, curtains etc.
8. Don't put the device near magnetic field, e.g. speaker. The normal function of the product may be disturbed by strong Electro-Magnetic Interference. If so, simply reset the product to resume normal operation by switching it off from the mains outlet and then switching it back on after several minutes.
9. Do not operate the player if it is not working normally or has been damaged in any way. Turn the unit off, unplug it from the power source and consult service personnel. Do not attempt to service this unit yourself.
10. Do not listen to headphones at high volumes. The excessive sound pressure from headphones can cause hearing loss.
11. Please observe the local regulations regarding the disposal of packaging materials, exhausted batteries and old equipment.

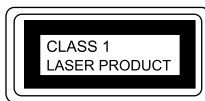
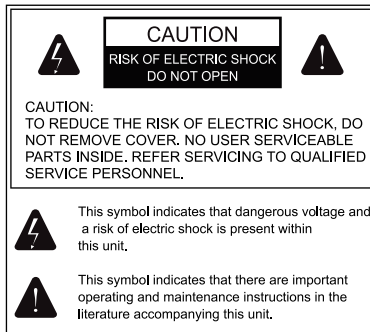

Power supply

1. Do not operate the product with wet hands. Doing so may cause electric shock.
2. Always turn the power off and remove the adapter from the outlet when the appliance is not to be used for a long period of time and before cleaning.
3. Power supply cords should be routed so that they are not likely to be walked on or pinched by items placed upon or against them.
4. Do not let the power cord hang over the edge of a table or bench top or touch any hot surface. Do not operate the appliance with a damaged cord or after the appliance has been dropped or damaged in any manner. If damage is suspected, do not attempt to repair or disassemble the appliance by yourself. Contact qualified service personnel if you need help.

Operation and position

1. Do not connect accessories, which are not approved by the manufacturer.
2. Do not abruptly increase the volume to high levels. Doing so may damage the player speakers.
3. Press the player's buttons gently. Pressing them or the screen too hard can damage the player.
4. Slots and openings in the cabinet are provided for ventilation and to ensure reliable operation of the product and to protect it from overheating. These openings must not be blocked or covered.
5. Do not drop the unit or expose this product to harsh impacts. This is a complicated electronic device that cannot withstand shock from drops.
6. Protect the player against extreme weather, moistures and high temperature . Do not use the player in an extremely dry environment, as this can lead to static discharge, which can damage the player.
7. Keep the appliance away from rain and any moisture.
8. Keep the player clean and never store it next to a heat source or in dirty, humid or wet places. Do not expose the player and the remote control to direct sunlight.
9. Ensure that your headphones are inserted into the player before it is switched on. Inserting them afterwards can potentially damage the headphones and the player.
10. Earphone cables may be hazardous to young children. Store the product carefully when it is not in use.
11. Keep "Earbud" style earphones out of reach of small children. "Earbud" earphones may be swallowed if they are placed in mouth.

Caution: Not performing controls and functions as stated in this manual may result in hazardous radiation exposure or other unsafe operation.

Service and maintenance

1. Servicing - Do not attempt to service this product yourself as opening or removing covers may expose you to dangerous voltage or other hazards. Refer all servicing to qualified service personnel.
2. Damage Requiring Service - Unplug this product from the wall outlet and refer servicing to qualified service personnel under the following conditions:
 - a. When the AC adapter or Car adapter is damaged.
 - b. If liquid has been spilled, or objects have fallen into the product.
 - c. If the product has been exposed to moisture or water.
 - d. If the product does not operate normally by following the operating instructions. Only adjust controls that are covered by the operating instructions as an improper adjustment of other controls may result in damage and will often require extensive work by a qualified technician to restore the product to its normal operation.
 - e. If the product has been dropped or damaged in any way, and when the product exhibits a distinct change in performance, service is needed.

Cleaning and care

1. Always turn the power off and unplug it from the outlet before cleaning.
2. Never spray or pour liquids directly on the screen or plastic casing, and clean with a dry towel only.
3. Do not clean the unit with strong chemical agents or abrasive cleaners.
4. Do not allow residue or liquids to enter any part of the appliance as this may cause risk of electrocution.
5. Be sure to remove the disc from the player before packing for moving.

PACKAGE CONTENTS

Please make sure the following items are included in package. If any item is damaged or missing, contact your dealer.



Master screen and slave screen.

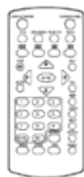

Remote Control



Car Adaptor



AC Adaptor



AV Cable



Instruction Manual



Headrest Mount straps (2pcs)





DC Power Cable for connecting the main unit and monitor

OPTICAL DISCS

Disc Requirements

This DVD player supports playback of the following discs and formats.

Type	Disc Mark	Content Type	Disc Size	Max. Playback Time
DVD-Video Discs		Audio + Video (Moving picture)	12cm	133 min (SS-SL)
				242 min (SS-SL)
				266 min (DS-SL)
				484 min (DS-SL)
Audio Compact Discs (CDs)		Audio	12cm	74 min
JPEG Photo CDs	--	Still Picture	12cm	--

This unit can play CD-R and CD-RW discs that contain JPEG picture files. This unit doesn't support the discs, which are not listed above.(e.g., PC CD-ROM, CD-Extra, CD-G, CD-I, etc.)

Disc Care And Maintenance

Optical discs (DVD, VCD, CD) contain high-density compressed data and need proper handling.

Handling A Disc

- Hold a DVD/VCD/CD disc by its edge.
- Avoid touching the recorded side of the disc. To remove a DVD/VCD/CD from its storage case, press down on the center retention mechanism of the case and lift the disc out.
- Do not subject discs to prolonged exposure to direct sunlight, high humidity, or high temperatures.
- Do not bend or press disc.
- To reduce the risk of scratches, always put disc back in its case after use. Store disc vertically in a cabinet.
- Do not place stickers or labels on either side of a disc.



Cleaning a disc

- Use a dry, soft cloth to wipe off any fingerprints and dusts from the playing surface of the disc.
- Wipe in a straight line radially from the center to the outside edge of the disc. Small dust particles and light stains will not affect playback quality.
- Never use chemicals such as record sprays, anti-static sprays, benzene, or thinners to clean a disc. Doing so will damage the surface of the disc permanently.

CONNECTIONS

Before Connecting To Any Device

1. Ensure that the player and other external equipment being connected are switched off before connecting.
2. Read the instructions carefully before connecting other external equipment.
3. Ensure that you observe the colour coding when connecting audio/video cables.

Connecting External TV/Monitor

Your player comes equipped with an AV output jack. Use this feature to connect the player's signal to external equipment (e.g. TV, monitor). Please refer to the image (a) as below to connect them;

Connecting External TV

1. Connect the 3.5mm – RCA Cable (not included) to the AV Output on the unit and the audio/video inputs on the Television (Red to Red, White to White and Yellow to Yellow).
2. Turn the unit on by switching the Power Button to the ON position.
3. Change the television to the correct audio/video input setting.
4. Audio and the video played through the unit will now be seen and heard on the connected television.

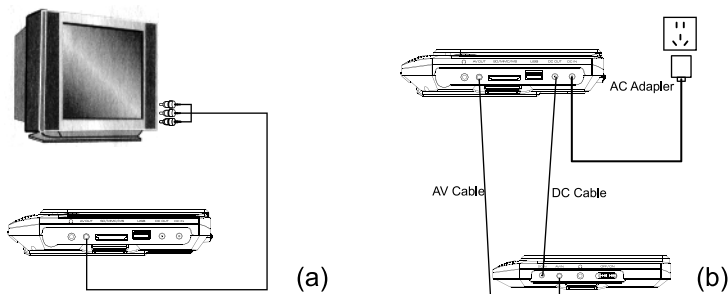

Connecting the unit to the monitor

1. Connect the AV Cable to the AV Output on the main unit and the AV Input on the monitor unit.
2. Connect the DC Cable to the DC Output on the main unit and the DC Input on the monitor unit. Please refer to the above diagram (b)
3. Switch the unit and the monitor on by switching the Power Button to the on position.
4. Audio and the video played through the main unit will now be seen and heard on the connected monitor unit.

How To Use The Headrest Mount

1. Use the provided straps and the headrest mount slot on the bottom cabinet to attach the headrest mount on the main unit and monitor, refer to the below picture,
2. Attach the unit on the car headrest using the velcro of the headrest mount, refer to the below picture. And then connect the power source and AV connection.
3. The remote control could be used directly when the unit attached the car headrest. Point the remote control towards the remote sensor of the main unit when operating.

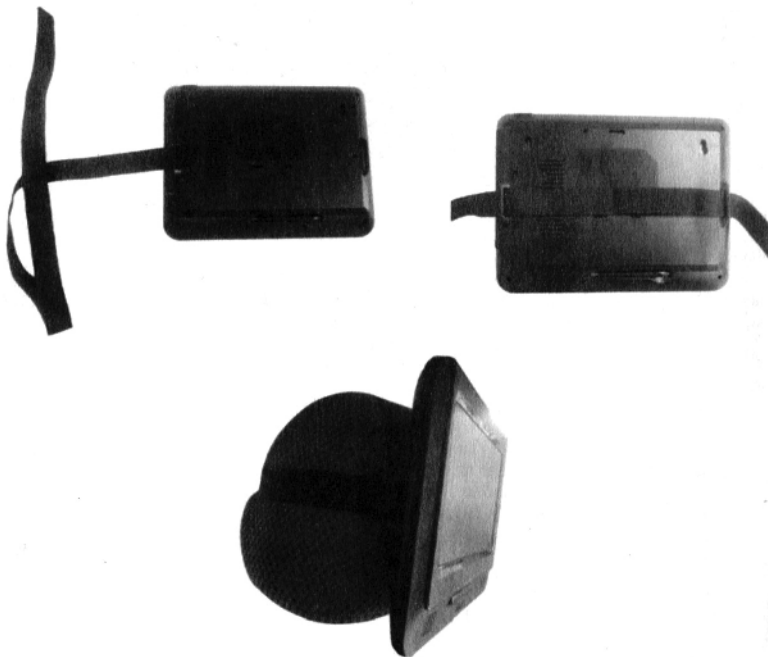

How To Use The Stand Of The Main Unit

Pull out the stand in the bottom cabinet of the main unit, the main unit can stand on a flat surface by itself.



Connecting Headphones

A stereo headphone jack has been provided on the player for private listening.

To use this jack, plug in the headphones (not included) with a stereo mini-jack 3.5mm plug to the jack and adjust the volume to a comfortable listening level. 

Note:

1. When headphones or earphones are connected to the earphone jack, the main speakers will be automatically muted.
2. Be sure that your player is set at a low volume level before connecting the headphone.
3. Increase the volume gradually for comfortable listening.

Caution: Listening at high volumes for a long period could cause hearing loss.

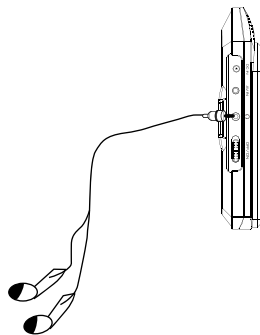

Connecting Power Supply

AC Adapter Operation

Before connecting the supplied AC adaptor to the wall outlet, ensure that all other connections have been made.

Insert the small plug of the supplied AC adaptor firmly into the DC IN9V-12V jack on the right side of the player, and then insert the adaptor into an available AC 100-240V~50-60Hz wall outlet.

Warning: Only use the supplied adaptor. Failure to do so may cause a fire or damage to the player. Never make or change any connections with the power switched on.

Caution:

- Do not connect the adaptor to a power outlet other than which is indicated here and on the label as this may result in the risk of fire or electric shock.
- Do not handle the plug of adaptor with wet hands. Doing so may cause electric shock.

Car Adapter Operation

Before connecting the supplied car adapter, ensure that all other connections have been made.

Insert the small plug of the supplied car adapter firmly into the DC IN jack on the right side of the player, and then inserts the other end into the Cigarette lighter socket.

Warning:

- Disconnect this car power adapter when the unit is not in use for long period of time.
- DO NOT plug the car adaptor to any automobile cigarette lighter in DC24V. Only the DC12V of the automobile cigarette lighter socket can be used. Connecting the car adaptor to a power supply with a different voltage can damage the unit.
- The Car adaptor is for in-car use only.

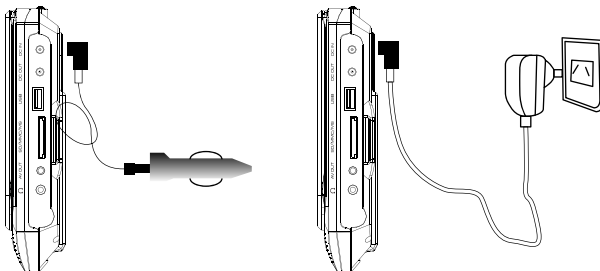

Note:

- *This portable DVD player requires external power to operate; otherwise it cannot be operated; using either the car or wall charger to power it. When disconnected from external power the unit and monitor will turn off accordingly.*
- *Only use the AC adaptor and Car adaptor supplied to power the main unit do not use AC adaptor to power the monitor.*
- *Do not use the unit in high temperature or near heat sources.*
- *The product has a voltage protection; the player needs to be disconnected from the power supplier in order to reset it if there is no power or response during the operation.*

FUNCTIONAL OVERVIEW

DVD Player View

SOURCE PRESS TO CHANGE BETWEEN DVD, USB OR MEMORY CARD PLAYBACK
SETUP PRESS TO ENTER THE SETUP MENUS ON THE MONITOR
OK PRESS TO CONFIRM A SELECTION IN THE SETUP MENUS
DURING PLAYBACK PRESS **OK** TO PAUSE PLAYBACK. PRESS **OK** AGAIN TO RESUME PLAYBACK
ARROW DIRECTIONAL BUTTONS USED TO SCROLL THROUGH SETUP MENUS
DURING PLAYBACK PRESS THE LEFT **ARROW** BUTTON FOR FAST REWIND. PRESS THE RIGHT **ARROW** BUTTON FOR FAST FORWARD
VOL - PRESS TO DECREASE VOLUME
VOL + PRESS TO INCREASE VOLUME

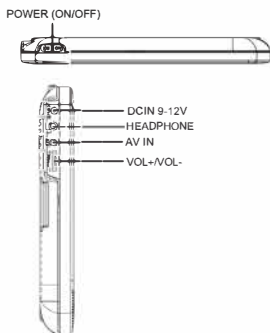
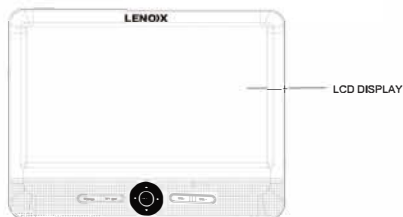
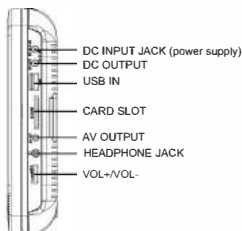
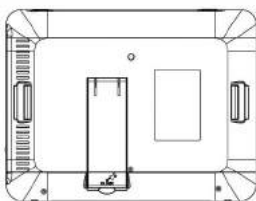
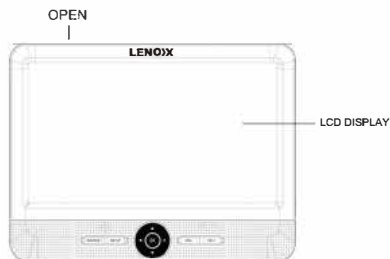

POWER: PRESS TO POWER ON THE SLAVE SCREEN.
TFT OFF: PRESS TURN THE DISPLAY OF THE SLAVE SCREEN OFF OR ON.
MENU: PRESS TO ACCESS SETTINGS FOR THE SLAVE SCREEN.
ARROW DIRECTIONAL BUTTONS: USED TO SCROLL THROUGH THE SETTINGS FOR THE SLAVE SCREEN.
VOL -: PRESS TO DECREASE VOLUME.
VOL +: PRESS TO INCREASE VOLUME.

THE REMOTE CONTROL DOES NOT FUNCTION WITH THE SLAVE SCREEN.

REMOTE CONTROL

Using the Remote Control

Point the remote control towards the main unit when operating.

The remote control works best at a distance less than 5 m and at an angle of up to 30 degree to the front of the unit. No obstacles may stand in the way between remote control and infrared sensor and do not place the remote control in direct sunlight. If the remote control fails to work even when it is operated near the player replace the battery.

Notes on batteries

If the remote control is not used for a long period of time, please remove the battery from the compartment.

Do not heat batteries or dispose of them in fires.

Do not dismantle, deform or modify batteries.





Requires 2 x AAA batteries (not included)

Remove the battery cover from the rear of the remote control.

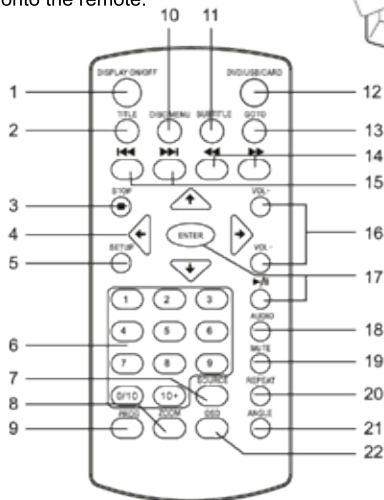
Add the batteries to the battery compartment as per the correct polarity.

Put the battery cover back onto the remote.



1. **DISPLAY ON/OFF:** Press it to switch on/off the TFT LCD panel.
2. **TITLE:** Press to view the title menu on a loaded DVD.
3. **STOP:** Short press to stop the audio/video/photo playback.
4. **DIRECTION BUTTON:** Press direction buttons     to move the cursor in the menu upward, downward, to the left, or to the right, respectively.
5. **SETUP:** Press it to go to the Setup menu directly.
6. **0-9 & 10+Number Keys:** Use the Numeric buttons to input a DVD chapter or CD track (invalid for some discs) and press **PLAY/PAUSE** button to confirm.
7. **SOURCE:** Press to search the chapter/track.
8. **ZOOM:** For the DVD disc, short press to access the zoom function, you can select the 2X, 3X, 4X, 1/2, 1/3, 1/4. For the photo disc, press it to switch between the zoom 100%, 125%, 150%, 200%, 75%, 50% and normal status.
9. **PROG:** Press to program a loaded disc to play chapters and titles or tracks in a specified order.
10. **DISC MENU:** Press to view the main menu on a loaded DVD.
11. **SUBTITLE:** Short press to Changes subtitle mode.
12. **DVD/USB/CARD:** Press the key to switch between DVD, CARD and USB mode.
13. **GOTO:** Press it to goes to a specific time index/title/chapter.
14. **Fast Forward / Fast Rewind:** Skips forward, consecutive short presses to go to 5-level speed (X2->X4->X8->X16->X32 ->PLAY); Skips backwards, consecutive short presses to go to 5-level speed (X2->X4->X8->X16->X32 ->PLAY)
15. **PREV/NEXT:** Press to play previous chapter/title/track. Press to play next chapter/title/track.
16. **VOL-/+:** Press to adjust the volume.
17. **PLAY/PAUSE / ENTER:** Press it to play or pause the audio/movie playback. Confirms the selection or press it to select the file to play.
18. **AUDIO:** Press to switch the available audio channels provided by the disc.
19. **MUTE:** Press the key to mute the audio of the player. Press it again to activate the sound.
20. **REPEAT:** Press repeatedly to cycle through repeat options for the loaded disc.
21. **ANGLE:** Press and hold to access different viewing angles on supported DVDs.
22. **OSD:** Press to display the information of the current video/audio.

BASIC OPERATION

Depending on the discs, some operations may be different or restricted.

Do not put any objects other than disc on the disc tray. Doing so may cause the player to malfunction.

Note:

- If a "  " mark appears on the screen when a button is pressed, it means the function is not available at the moment on the current disc or at the current station.
- Depending on the conditions of the recording equipment or the CD-R/ RW (or DVD \pm R/RW, MP3, Picture CD) disc itself, some discs cannot be played on this player due to the configuration and characteristics of the disc, or due to the condition of recording and digital copyright software that was used.

Disc error messages

If there is a problem with the format of the loaded disc, then the disc cannot be played correctly.

- The region code of the disc does not match the player's region code .
- The parental rating level of the disc is higher than the parental rating level setting of the player. The player will not play the disc. .
- Bad/No disc: The player is equipped with automatic disc quality detection software. If the player detects a disc that is damaged or has a format problem , it may play the disc at a lower quality or stop playing completely, depending on how serious the damage is.

Note: DVD disc production quality may vary and some discs may deviate from the industry standard. Some incorrectly formatted discs may still play, however, the playback and operational quality of the disc may be substandard.

Playable discs

This player will play CD, VCD, DVD, CD-R/RW and DVD±R/RW etc. discs.

Note: If you have trouble with playing a certain disc, remove the disc and try a different one. Improperly formatted discs will not play on this player.

Turn on/ off the player

Turn on/off the main unit

Slide the **Power switch** on the top side of the main unit to "ON" position to turn on the player after connecting the mains power supply. Slide the **Power switch** on the player to "OFF" position to turn off the player completely.

Turn on/off the monitor unit

Slide the **Power switch** on the right side of the monitor unit to "ON" position to turn on the player after connecting the DC cable with the main unit. Slide the **Power switch** on the player to "OFF" position to turn off the player completely.

Note: If the player will not be in use for a long period of time, slide **Power switch** to the "OFF" position and unplug the portable DVD player from the power source.

Selecting the different mode (DVD/USB/CARD)

During the DVD or USB/Card playback mode, press the **USB/CARD** button on the remote control to select DVD or USB or SO play mode if certain disc or memory devices are connected. When a USB mass storage device is simultaneously inserted, the USB device can be recognized. **Note:** USB, SD/MMC card supports up to 32GB, and video files supported are up to resolution 720*576.

Playing discs

1. Slide the **Power switch** on the player to "ON" position to turn on the player.
2. Open the disc cover and insert a playable DVD or CD disc, Make sure the label side is facing up, and then close disc cover.
3. The player will scan the disc, and then the **layback will start automatically.**
If a disc menu appears on the screen, see "**Using the disc menu**" for details.
4. If the disc is locked by parental control, you must enter your password (see "SYSTEM SETUP" section for details).
5. During the playback, press the **STOP** button stop playback.
6. Sliding the **Power switch** on the player to "OFF" position will turn off the player.
7. Press the **PBC** button on the remote control to activate or deactivate the PBC function. PBC playback allows you to play Video CDs (VCD version 2.0 only) interactively.
8. Press the **MUTE** button on the remote control to turn on or off the sound.
9. Press the **Go To** button on the remote control to select the play time
- 10.Short press the **LANGUAGE** button on the remote control to select the audio soundtrack languages; (one DVD recorded with this multiple languages has this function, some recorded DVD may not have this function). Press the **ANGLE** button to use the picture angle while playing a DVD disc that has been made with multiple angles. Only the DVDs shot with multi-angle scenes have this function .
11. Press the **REPEAT/PROG** on the remote control button to re-configure the playing order.

Using the disc menu

Depending on the disc, a disc menu may appear on the screen once you load the disc.

1. From the file/ folder list menu, using the **Direction buttons (UP/DOWN)** to select the desired playable file and press the **ENTER** button to start playback.
2. If the desired file is saved in a folder, press the **Direction buttons (UP/DOWN)** to select the saved folder and press the **ENTER** button to open the folder.

Return to the root menu or title menu

During the disc playback, press the **MENU** button to return to the disc's root menu or title menu (depending on disc). For the MP3, Picture disc, press it to go to the file or folder list after pressing the **MENU** button or stop button. Use the **Direction buttons (UP/DOWN/LEFT/RIGHT)** or the **Numeric buttons** to select a play option. Press the **ENTER** button to confirm and start playback.

Play/Pause the playback (DVD/CD/MP3)

During the playback, press the **PLAY/PAUSE** button on the remote control to pause the playback and sound will be muted. Press it again to resume playback.

Volume control

Press the **VOL+ / VOL-** button on the player or the remote control to increase or decrease the volume level. Press the **VOL+/-** button on the monitor to adjust the volume level.

To switch off the volume temporarily by pressing the **MUTE** button on the remote control, playback will continue without sound, press it again or press the volume button to activate sound;

Selecting a track/ chapter/ title (DVD/ VCD/ CD)

Press the **PREVIOUS ◀** or **NEXT ▶** to skip to the previous or next title/ chapter/ track.

Stop playback (DVD/ VCD/ CD)

During playback, press **STOP** button to stop playing the disc.

Fast forward / Fast backward searching (DVD/ VCD/ CD/ MP3)

During playback, press **▶▶** or **◀◀** button on the remote control repeatedly until the desired speed is reached for fast searching within a track/chapter/title (forward or backward). Press the **PLAY/PAUSE** button will enter normal playback directly.

2X → 4X → 8X → 16X → 32X → Normal

Note: The function is invalid on some discs. Not support the photo playback.

Slow Motion Playback (DVD, SVCD, VCD)

Press the **SLOW** button on the remote control when pictures moving, you can enter Slow Motion Playback mode.

Press the **SLOW** button on the remote during playback. Press the button again on the remote to play at the next speed. Slow Motion Playback has four speeds: 1/2, 1/4, 1/8, 1/16, and normal playback with each consecutive press of the button, the play speed decreases. If you press button for five times, Slow Motion Playback cycles back to normal playback.

Press the **PLAY/PAUSE** button to resume normal playback.

Repeat A-B (DVD/ VCD/ CD/ MP3) playback

Using this feature to repeat playback of a specific section of a track/chapter (loop).

Press the **Repeat A-B** button on the remote to set the desired start point of the section to be repeated.

Press the **Repeat A-B** button on the remote again to set the desired end point of the section to be repeated.

The section "A-B" will now be played repeatedly as a loop.

Press the **Repeat A-B** button the third time to cancel the repeat A-B feature and resume normal playback.

Repeat Playback (DVD/VCD/CD/MP3/Xvid disc)

You can play a chapter/ title/ all/ track on a disc repeatedly. Press **Repeat** button on the remote control repeatedly during playback to select a desired repeat mode. Depending on the kind of disc (DVD, VCD, CD, MP3 or Video photo discs), you have different repeat modes.

Program Playback

For DVD/VCD disc

- During playback, press the **PROGRAM** during the playback mode.
- Use navigation buttons to scroll through the different fields. Use numeric keypad to enter valid title/chapter number. Maximum of 20 sequences can be programmed.
- Select Play and the press **ENTER** to start playback.
- To clear the whole program, select Stop and press **ENTER**.

Note: Some video and JPEG disc do not support this function.

Zoom (DVD/ VCD)

Press the **ZOOM** button on the remote control repeatedly to change the video image during playback.

- During DVD, VCD playback, each successive press of **ZOOM** will change the level of magnification. While at **ZOOM 2X, 3X, 4X, 1/2, 1/3 and 1/4** and normal; use the **Direction buttons (UP/ DOWN/ LEFT/ RIGHT)** on remote control or the unit to view the other parts when the photo is magnified (2X, 3X, 4X, 1/2, 1/3 and 1/4 mode can be operated). During the slideshow mode of the JPEG CD or JPEG file in the USB device, press the **ZOOM** button on the remote control to zoom in or zoom out the photo. Press the **ZOOM** button repeatedly to select the zoom level, the screen shows the zoom level, includes the 100%, 125%, 150%, 200%, 75% and 50%. When a picture is magnified, you can press the **Direction buttons (UP/DOWN/ LEFT/ RIGHT)** on the remote control to view other panel parts of the magnified picture.

Note: Zoom may not work on some disc. The picture quality decreases as the picture size increases.

Selecting Subtitle Languages (Dvd)

While playing a DVD disc that has been mastered with multiple subtitles, press the **Subtitle** button repeatedly to select the desired language of the viewable subtitle.

Note: Only DVDs recorded with multi-language subtitles have this function.

Changing The Audio Soundtrack Languages (Dvd)

Press the **Language** button on the remote control repeatedly during playback to select different audio languages.

Note: Only DVDs recorded with soundtrack languages have this function. Some recorded DVD disc or video files without this function.

Changing The Audio Channel (Cd/mp3/vcd)

Press the **Language** button repeatedly during playback to select available audio channels provided by the VCD disc (Left Mono, Right Mono, Mix-Mono or Stereo).

Information Display

During playback, press the **DISPLAY** button repeatedly to show the disc playback information on the screen (video format, time, title and chapter etc.)

Note: Depending on the kind of disc (DVD, VCD, CD or Data discs), different information will be shown on display.

Numeric Buttons

Use the Numeric buttons to input a DVD chapter, VCD or CD track (invalid for some discs) and press the **ENTER** button to confirm.

Select "1-9", press the numeric button directly;

Select "10-99", press the "10+" button to select the number on ten digits, the number increase along with the number of the button press, press the number directly to select the number on unit digit.

Using The Search Feature (DVD/CDI/CD)

Note: The function is invalid on some discs.

1. When Playing DVD disc

Search by title, chapter or time; Stop the playback at a specific point, and then press the GOTO button: The search window appears on the screen.

Use navigation buttons to select a search option:

- Title: Enter the title number using the numeric keypad.
- Chapter: Enter the chapter number using the numeric keypad.
- Disc Time: Use navigation buttons to select a field (minutes, seconds). Use the numeric keypad to enter the field values.

2. When Playing VCD disc

- Disc Time: Use navigation buttons to select a field (minutes, seconds). Use the numeric keypad to enter the field values.
- Track: Enter the track number using the numeric keypad.

3. When Playing CD disc

Use navigation buttons to select a search option:

- Disc Time: Use navigation buttons to select a field (minutes, seconds). Use the numeric keypad to enter the field values.
- Track: Enter the track number using the numeric keypad.

SPECIAL FEATURES

MP3/WMA/AVI Playing

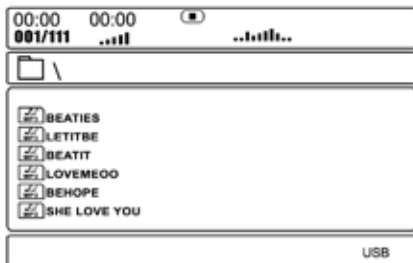

The MP3/WMA/AVI disc has a directory structure as shown in the picture.

Press the Direction key to choose the root directory and then press the **ENTER** button to enter into the sub directory. Press the Direction key to choose the desired track and then press the **ENTER**

button to enjoy the music or movie. You can press the program button to change the file list and fold list;

If you want to return to the upper menu, press the Direction key to choose the  icon and press the ENTER button.

Photo/picture CD Playback

The PICTURE CD disc has such a directory structure as shown in the following picture.

Press Direction key to choose the desired picture and then press the ENTER button to enter into the sub directory. Press Direction key to choose the desired picture

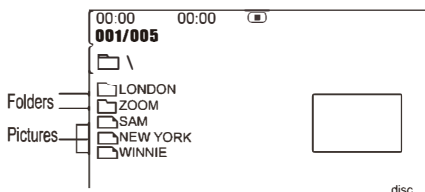

and then press the ENTER button on the remote control to view the picture. The player will show the pictures by slideshow mode automatically, press the play/pause button to pause or restart the slideshow. Press the stop to turn to the Browse mode. Press Menu if you want to return to the menu.

NOTE: The quality and playing speed of JPEG photos depend on the resolution and the compression ratio of the photos. Some JPEG photos may not be played due to discs quality and the formats. Not all video files are played well since the difference video codec.

Image rotation

In picture play state, press the Direction key to rotate the picture.

Connect to USB

You can play or view the supported data files such as the MP3, Video files in AVI format, photos in JPEG format.

Insert the USB stick into the USB port on the right hand side of your portable DVD player. The portable DVD player supports USB devices up to 32GB flash memory. (Note: not all USB devices can be read. Not all movie files in your USB device can be played.)

When the disc playback is in stop mode, press the source button on the unit or the remote control, and then press the direction button of the UP/DOWN to select the USB, press the ENTER button to switch to USB mode.

And then select the file you want to play by pressing the direction button.

USB interface

Playing from a USB interface is the same as playing back from a DVD disc.

Note: the USB IN port is compatible with flash memories; it is not warranted the compatibility with MP3 players using owner software.

NOTE:

Please do not insert in the wrong direction, or it will be corrupted. Always stop the playback or change to other mode before removing the USB device.

Connect to SD/MMC Memory Card

1. Plug a SD or MMC card into the SD/MMC Memory Slot.
2. Switch unit to Card Mode by pressing the USB/CARD button
3. Use the Directional buttons to select videos or images. Press the Enter button to play.
4. The portable DVD player supports the Memory Card device up to 32GB flash memory. **Note:** Before removing the memory card, always press STOP button to stop playback.

USB/ SD/ MMC Card Storage Device Protection

The operating features described here might not be possible for some USB devices or SD/ MMC memory cards. Always refer to the instructions supplied with external devices.

Always insert the SD/MMC card in the correct direction. Failure to do so may result in damage to the memory cards and this player. Do not force the memory card into the slot.

Not all USB and memory cards can be recognized in this player. If you have trouble with playing a file, remove the SD/MMC card or USB device and try a different one. Improperly formatted files will not be played on this player.

Electrical interference and electrostatic discharges may cause the USB device or SD/MMC card to malfunction and suffer damage, resulting in data loss. It is strongly recommended that any important data is backed up on a PC to protect against corruption, data loss or device malfunction.

SYSTEM SETUP

To access the setup menu, press the setup button on the remote control. You will be given four sub menu options to choose from . Each option is described below. Use the arrow keys to navigate between the options.

GENERAL

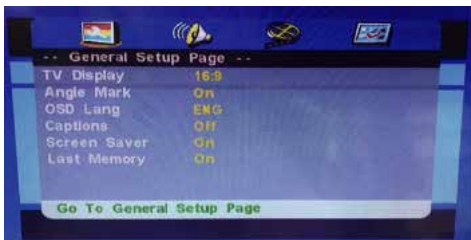

The general menu allows you to modify basic setting such as language. The general options are as follows:

- TV Display: Adjust the screen aspect ration between 4:3 Pan Scan/4:3 Letter Box/16:9
- Angle Mark: Display an icon on the screen when multiple angles are available
- OSD Language: Allows you to change the menu language
- Captions: Display subtitles automatically when available
- Screen Saver: Display a screen saver when the portable DVD has not been used for a period of time
- Last Memory: Revert back to the same spot on a DVD if the portable DVD is turned off in the middle of a Program

SPEAKER

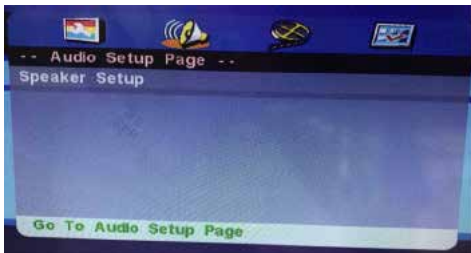

The speaker menu allows you to change the audio setup of the portable DVD
- Downmix: Set downmix to LT/RT, Stereo

VIDEO SET UP PAGE

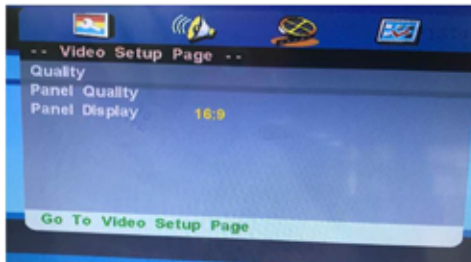

The QUALITY menu allows you to change the video quality settings on the portable DVD player.

- Sharpness: Adjust the screen sharpness between LOW/MED/HIGH
- Brightness: Adjust the screen brightness
- Contrast: Adjust the screen contrast
- Gamma: Adjust the gamma
- Hue: Adjust the hue
- Saturation: Adjust the Saturation

The PANEL QUALITY menu allows you to change the display properties on the portable DVD player.

- Sharpness: Adjust the screen sharpness between LOW/MED/HIGH
- Brightness: Adjust the screen brightness
- Contrast: Adjust the screen contrast
- Hue: Adjust the hue
- Saturation: Adjust the Saturation

The PANEL DISPLAY allows you to change the aspect ratio.

PREFERENCE SETTINGS

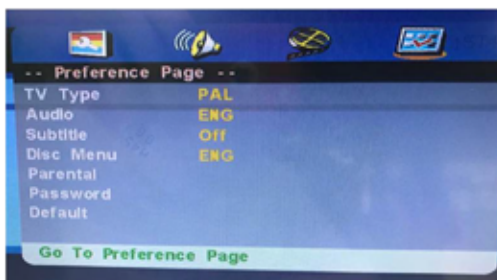

The preference page allows you to adjust the default DVD disc settings (This setting is only available when there is no disc inside the unit).

- TV Type: Set TV type to PAL, AUTO or NTSC

- Audio: Set the default audio language
- Subtitle: Set the subtitle language
- Disc Menu: Set the disc menu language
- Parental: Set a maximum parental rating for disks that can be played without a password
- Password: Set a parental lock password (The default password is 0000)
- Default: Return the portable DVD to factory default.

PANEL QUALITY FOR THE SLAVE MONITOR



Press the menu button on the monitor unit, then the panel quality menu for monitor unit will appear, press the up and down button to select BRIGHT, CONTRAST, COLOR and LANGUAGE, RESET

press the VOL- and VOL+ button to adjust the values.

Note: Please allow the DVD player up to five seconds with any operation to save the new settings. The remote control do not support the setting of the monitor.

Troubleshooting

Check the following Troubleshooting guide in the following section before contacting Customer Support. Do not attempt to repair the DVD player by yourself.

Turn off the DVD player immediately as soon as you suspect a malfunction. Unplug the power and check whether the DVD player is unusually warm or whether smoke is rising from it.

Other possible causes for problems:

Static discharges or other external interferences can cause the DVD player to malfunction. When this happens, disconnect the power plug from the mains socket and plug it back in.

If the problem persists, disconnect the device from the mains again and contact Customer Service or a repair shop.

Problem	Possible cause	Solution
The DVD player does not work	Disc cover not closed	Close disc cover
	No disc inserted	Insert disc
	Disc inserted the wrong way Disc dirty or scratched Regional code of the player does not match the regional code of the DVD	Insert disc with label facing up Clean disc, or insert other disc Purchase DVD with corresponding regional code
	Moisture on lens	Remove disc and turn off DVD player for at least two hours
No sound	Device not properly connected	Check connections and connect device connections securely
	Headphones connected (loudspeaker off)	Disconnect the headphones
	DVD sound settings incorrect	Check sound settings and set sound correctly
	Disc dirty or scratched	Clean disc, or insert other disc
No video	TV screen is off or in the incorrect video mode	Turn on LCD screen and/or set correct video mode
	Device not properly connected	Check connections and connect device in the correct way
Poor video and/or audio quality	Disc dirty or scratched	Clean disc, or insert other disc
Repeated playback of a section	Loop mode is switched on	Exit the loop mode
	Disc dirty or scratched	Clean disc, or insert other disc
Remote control does not work	Obstacle between remote control and DVD player sensors	Remove obstacles inbetween path of sensors
	Remote control not pointed at DVD player	Point remote control directly at DVD player
	Remote control battery inserted the wrong way	Check the battery's polarity and, if necessary, insert battery correctly
	Battery too low or completely discharged	Insert new battery

SPECIFICATIONS

Power Adaptor	AC Adaptor input power: AC 100-240V 50/60Hz Output: DC 9V (2A AC adaptor Terminal) Monitor: DC in 9V (from the DVD player terminal)
Power Supply	DC 9V-12V 12A
Region Encoding Playback	NTSC/PAL/AUTO
Disc Mode	DVD,VCD, CD, MP3, CD-R, CD-RW, JPEG, DVD±R/RW, AVI
Video S/N Ratio	≥ 65dB.
AV Out Resolution	≤ 500 lines
Frequency Response	fs 96kHz: 125Hz-16kHz: +/-1dB
Audio S/N Ratio	≥ 90dB.
Dynamic Range	≥ 80dB.
Distortion	< 0.01%
Headphone jack	3.5mm
AV in/AV out jack	3.5mm
D/A Converter	96kHz/24bit
Display Device	Color TFT-LED display, screen resolution is 800*480
Screen Size	22.75cm 9" widescreen (16:9) [22.6cm (8.89") viewable screen size] inches screen size
Operating Conditions	Temperature 0°C~40°C

NOTE: As a result of continual improvements, the design and specifications of this product are subject to change without notice and may differ slightly from the unit illustrated on the packaging.

LENOXX

www.lenoxx.com.au



1300 666 848



LenoxxElectronics



@LenoxxAustralia