

Healthy Choice™  
AF1200

# 12 LITRE DIGITAL AIR FRYER

---

ROLLING CAGE • ROTISSERIE FORK • *THREE* MESH RACKS  
MESH TRAY • DRIP TRAY • CAGE TONGS



Model: AF1200

Batch: PR4316

## **CAUTION:**

**TO AVOID DAMAGE TO YOUR BENCH TOP AND SPLASH BACK,  
DO NOT PLACE AIRFRYER DIRECTLY ON BENCH TOP.**

**Use air fryer on heat proof material and on a dry, level and even surface. Leave a minimum distance of 20cm from walls and other heat sensitive materials.**

**THIS APPLIANCE IS INTENDED FOR HOUSEHOLD USE ONLY.  
PLEASE READ AND RETAIN INSTRUCTIONS FOR FUTURE REFERENCE.**

The illustrations used in the manual are to illustrate the operation method and structure of the product. Where there is a small difference between the physical item and the illustrations, please take the physical as the standard.

### **ABOUT THIS PRODUCT:**

Your personal chef has arrived– and is equipped and ready to prepare meals for your entire family.

Whatever the occasion – the 12 Litre Digital Air Fryer has got you covered. Loaded with a rolling cage, rotisserie fork, three mesh racks, mesh tray, drip tray and cage tongs, this air fryer is packed and ready to make meals that will take your cooking to the next level (in just a fraction of the time!).

Better yet, this cutting-edge, circulating ‘turbo air’ technology cooks your food with minimum oil, while still providing maximum taste. Simply add your ingredients into its huge 12 litre capacity and wait as the air fryer circulates ‘superheated’ air up to 200°C. Watch as your food grills, roasts, fries or bakes its way to perfection behind our secure, retro glass viewing window which is also removable for cleaning. Enjoy three layers of rack levels so you can simultaneously cook meals and sides.

This 12 Litre Digital Air Fryer gives you the tools to cook your way to a healthier life – offering a low-fat, low-calorie, fast-cooking alternative that does not sacrifice taste or quality. The fully digitised display offers easy, modern pre-sets to help you find the corresponding cooking program. With an impressive 10 in-built cooking programs, you can choose from chips, beef, prawn, bake, chicken pieces, steak, fish, whole chicken, dehydrator and defrost. You can even set your own time up to 60 minutes and temperature between 65°C – 200°C as you cook a variety of meals. The dehydrate cooking program offers a time setting of 24 hours and temperature range of 30°C – 80°C.

With a rotisserie 360° food rotating option, you can enjoy crispy chips and even roasted nuts– all cooked to perfection. Healthy eating doesn’t have to be boring – pave your own path with a new way to prepare delicious food, at just the turn of a switch.

### **CAUTION:**

TO AVOID DAMAGE TO YOUR BENCH TOP AND SPLASH BACK, DO NOT PLACE AIR FRYER DIRECTLY ON BENCH TOP.

Please use air fryer on heat proof material and on a dry, level and even surface. Leave a minimum distance of 20cm from walls and other heat sensitive materials.

Do not place the appliance against a wall or against a wall or against other appliances.

Hot air up to 160 Degrees expels through the rear vent of the appliance.

Leave at least 20cm clearance around the entire appliance, including directly above it.

Additional care should be taken when placing appliances on bench top surfaces or near splash backs where such materials (Acrylics, timber, stone etc.) do not have the high heat resistant properties.

Place the appliance on top of a heat resistant material between bench and appliance and further away from wall surfaces/ splash backs.

### **IMPORTANT SAFEGUARDS:**

**When using electrical air fryers, basic safety precautions should always be followed, including the following:**

1. Read the instructions carefully before use.
2. Remove and safely disregard any packaging material and labels before using this product for the first time. Ensure children and babies do not play with plastic bags or any packaging materials.
3. Before use, check that your local voltage corresponds with the specifications shown on the appliance nameplate located under the appliance.
4. Always operate the appliance on a horizontal surface which is level, stable and non-combustible. Do not operate the appliance on or near combustible materials such as tablecloths or curtains.
5. Do not place the appliance on or near a hot gas or electric burner, or in a heated oven.
6. Never connect this appliance to an external timer or separate remote-control system.
7. Never use this appliance with an extension cord or power board. Ensure it is plugged into a dedicated power point and without any other appliances on the same outlet.
8. Do not turn on the power until the appliance and parts are in place as required. Make sure the door is closed before plugging in and switching on the power.

9. To protect against electric shock, do not immerse the cord, plug, or appliance in water or any other liquid. Do not expose the appliance to dripping or splashing and ensure that no objects filled with liquids such as vases are placed on the appliance. Do not put any water or other liquid into the main housing of the appliance through the vents. Do not rinse it under the tap.

10. Do not touch the appliance, power cord or power plug with wet hands.

11. Unplug from the outlet when not in use and before cleaning. Allow the appliance to cool down (if relevant) before putting on or taking off the parts, and before cleaning.

12. The appliance does not contain any serviceable parts inside. Do not attempt to open and repair the appliance yourself. All components should only be serviced by a qualified technician.

13. Do not use the appliance if the plug, power cable or unit itself are damaged. If the power cord is damaged, you must have it replaced at a service centre with qualified persons in order to avoid a hazard.

14. Do not use the appliance for anything other than the intended use. It is for household use only. It is not to be used outdoors or for commercial purposes.

15. Close supervision is necessary when any appliance is used near children. Keep the appliance and power cord out of reach of children when it is in operation or during the cooling process.

16. This appliance is intended to be used in household and similar applications such as:

- staff kitchen areas in shops, offices and other working environments;
- farm houses;
- by clients in hotels, motels and other residential type environments;
- bed and breakfast type environments.

17. This appliance should be operated on a separate electrical power point from other operating appliances. If the power point is overloaded with other appliances, this appliance may not work properly.

18. Extreme caution must be used when moving an air fryer containing hot food.

19. Leave enough open space from other objects while in use. Do not block air intakes or exhausts.

20. Do not place the appliance against a wall or against other appliances. Leave at least 20 centimetres of free space on the back and sides and above the appliance. Do not place anything on top of the appliance.

21. When the appliance is in operation, air is released through the air outlet vent. Keep your hands and face at a safe distance from the air outlet vent.

22. Do not touch the hot surfaces. The appliance's outer surfaces may become hot during use. The rolling cage and rotisserie fork set will be hot. Wear oven mitts or use the cage tongs to remove it. Wear oven mitts when handling the mesh pieces and drip tray.
23. Do not cover the appliance while in use.
24. Do not let the cord hang over the edge of the table or counter.
25. Do not unplug the appliance by pulling on the cord.
26. This appliance is not designed to be used by people (including children) with a physical, sensory or mental impairment, or people without knowledge or experience, unless they are supervised or given prior instructions concerning the use of the appliance by someone responsible for their safety. Children must be supervised to ensure that they do not play with the appliance.
27. Do not leave the appliance operating while unattended.
28. The appliance may emit light smoke during its first use. It is not defective, and the smoke will burn off within a few minutes.
29. Should the appliance emit black smoke, un-plug it immediately. Wait for the smoke to stop before removing the contents inside.

#### **SHORT CORD INSTRUCTIONS:**

Do not use with an extension cord. A short power supply cord is provided to reduce the risks resulting from being entangled in or tripping over a long cord.

#### **OVERHEATING PROTECTION:**

Should the inner temperature control system fail, the overheating protection system will be activated, and the appliance will not operate. Should this happen, unplug the power cord. Allow time for the appliance to cool completely before restarting or storing.

#### **ELECTRIC POWER:**

If the electrical circuit is overloaded with other appliances, this appliance may not operate properly. It should be operated on a dedicated electrical circuit.

#### **AUTOMATIC SHUT-OFF:**

The appliance has a built-in shut-off device that will automatically shut down the appliance when the timer LED reaches zero.

You can manually switch off the appliance by selecting the power button. The fan will continue running for about 30 seconds to cool down the unit.

## **PREPARATION FOR USE:**

Before using the air fryer for the first time:

Warning: when using for the first time, the air fryer may emit slight odour which is not harmful and will disappear after a few minutes. This is because a protective oil was applied to protect parts from possible friction in transport.

Carefully unpack the air fryer and remove all the packing materials.

Place the air fryer on a flat, heat-resistant non-flammable surface.

Use a soft sponge and soapy water to remove any dust on the surface that may happen during packing and transport. Allow the air fryer to dry before use.

**PARTS:**

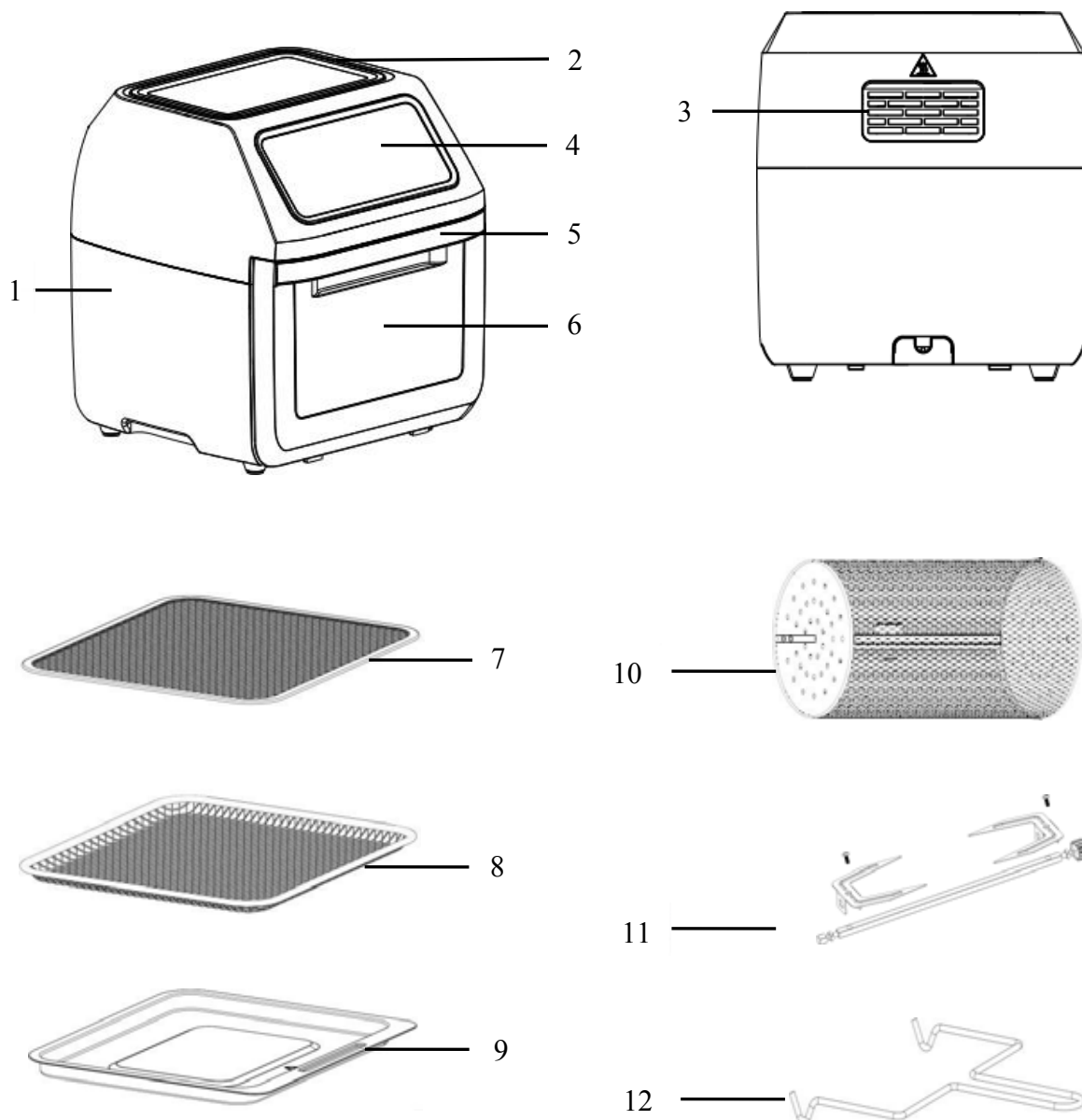

- 1. Main unit
- 2. Air inlet
- 3. Hot air outlet
- 4. Control panel
- 5. Door handle
- 6. Transparent door

- 7. Mesh tray
- 8. 3 x mesh racks
- 9. Drip tray
- 10. Rolling cage
- 11. Rotisserie fork set
- 12. Cage tongs

## **PRODUCT USE AND ACCESSORIES:**

\* Choose an accessory to use for different cooking styles.

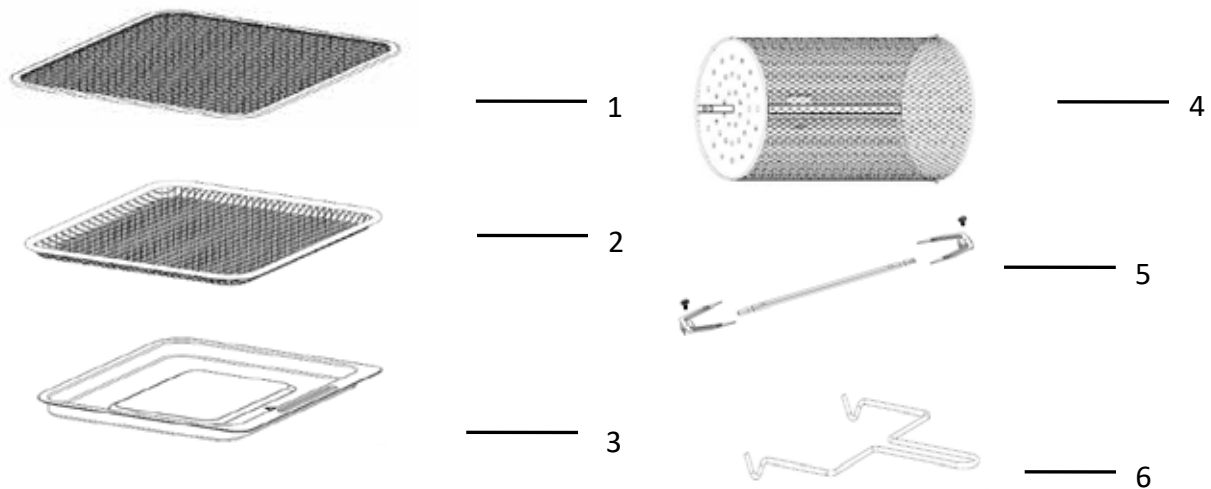

### **1. Mesh tray**

- The mesh tray can be used as a protection cover to prevent food from contacting the heating element at the top of the air fryer.
- To install the mesh tray protection cover, put the side with the wire handle face down then slide along the top plastic shelf near the heating element.
- To remove the mesh tray protection cover, pull by the wire handle.

### **2. 3x mesh racks**

- The mesh racks can be used for dehydrating snacks, cooking crispy snacks or reheating foods like pizza, etc.
- Ideal for multi-level cooking.
- Slide along the rack shelf to install or remove the three mesh racks.

**Note:** Please use your own oven mitts to remove the mesh tray and mesh racks after the cooking is complete.

**Note:** The food inside may increase in size during the cooking process, ensure that the heated volume of food will not touch the inside walls of the air fryer.

### **3. Drip tray**

- Cook with the drip tray at the bottom of the air fryer for easy clean-ups.
- Always keep the drip tray in the lowest layer inside the air fryer for gathering oil from fried food.

**Note:** Please use your own oven mitts to remove the drip tray after the cooking is complete.



#### 4. Rolling cage

- Great for chips, popcorn and roasting nuts.
- Use the clasp to open and lock the rolling cage.
- To install the rolling cage, slide in the rotisserie stick (on the cage) with the gear towards the left, then secure the grooves on the other end of the rotisserie stick (on the cage) into the rotating shelf.

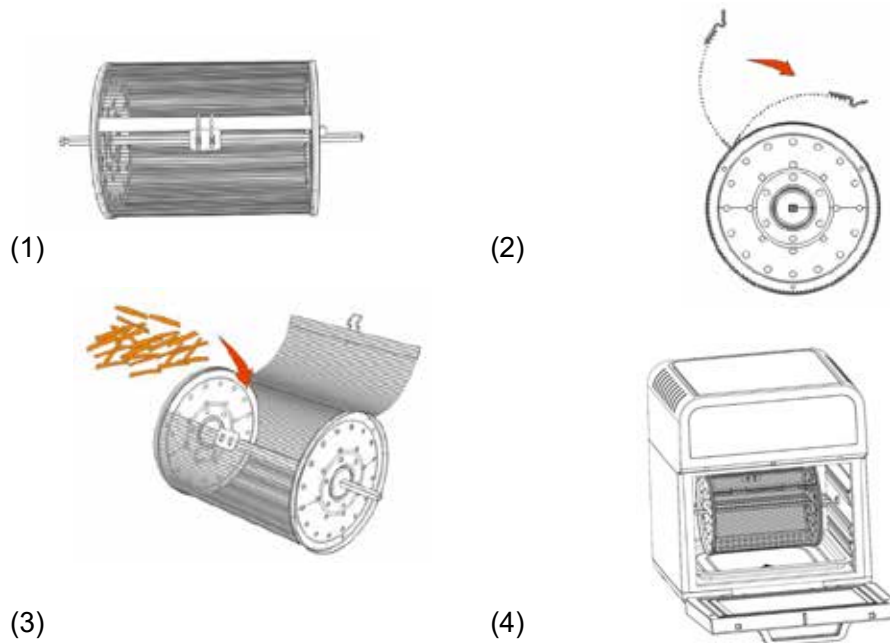

#### 5. Rotisserie fork set

- Use for roasts or a whole chicken. The max weight capacity for the rotisserie is 1 kilogram.
- Force the shaft length-ways through the meat and centre.
- Slide the forks onto the shaft from either end into the meat then lock into place with the screws. There is an indentation point on the shaft for a screw. Ensure the other screw is fitted tightly to the rotisserie stick.

**Note:** You can adjust the screws closer to the middle if needed, but never outwards towards the ends.

**Note:** Ensure that the roast meat or chicken are not too large and are able to rotate freely inside the air fryer.

**Note:** Tie up the chicken or other roast meat with cooking string to hold it tightly around the rotisserie stick.

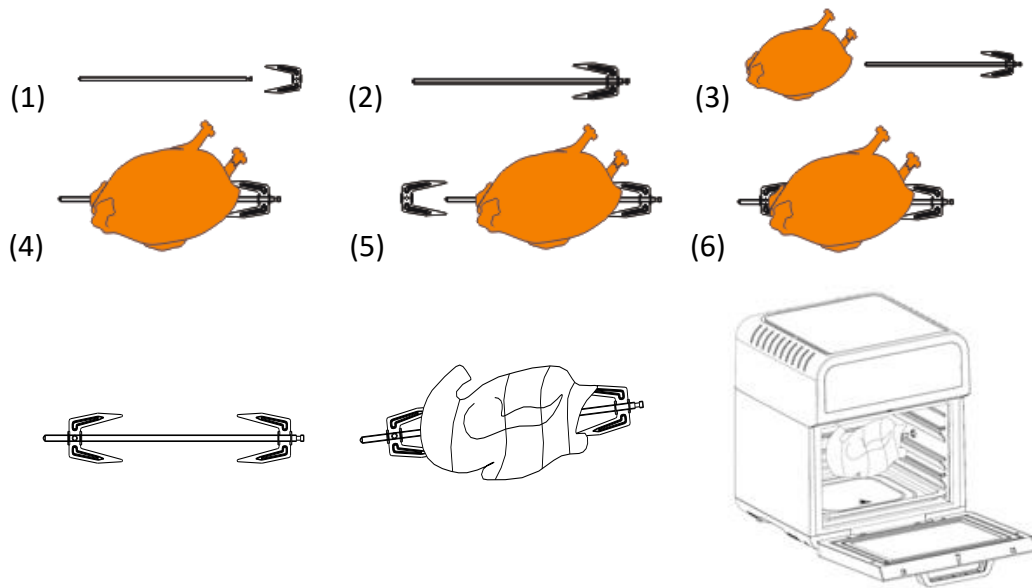

## 6. Cage tongs

- Use to remove roasts or chicken which have been cooked using the rotisserie and also for removing the rolling cage from the air fryer.
- Place under the rotisserie stick and then lift gently.

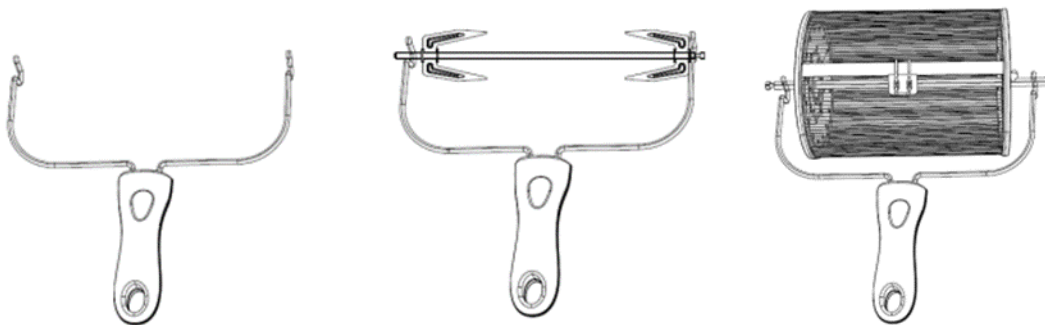

## REMOVEABLE DOOR:

- The door is detachable for easy cleaning.
- Open the door to a 30° angle and gently remove it by sliding it out and upwards.
- The removeable door can be washed in warm soapy water.
- The removeable door is not dishwasher safe.
- Reattach the door by holding it at a 30° angle and gently pushing it in and downward.

## CONTROL PANEL:



1.  Power / start–stop button: once the air fryer is plugged in, it will beep once, then the screen will light up and then go off. The power button will remain illuminated.

- Press the power button and hold down for 3 seconds to turn the screen on.
- Pressing the power button a second time will activate the cooking process at the default temperature of 180°C and time of 15 minutes.
- Pressing the power button for two seconds at any time during the cooking process will shut down the air fryer, causing the screen to display OFF. The fan will continue running for up to 30 seconds to cool down the appliance.

2. Food icon buttons: press these buttons to choose a preset cooking program that you wish use. When your chosen option is blinking on the screen, press the power button to begin the cooking process. Please see the below section of preset cooking times and temperatures for further information.

3.  Internal light: this button will help you check the cooking progress while the air fryer is in operation.

**Note:** Opening the door during the cooking process will pause the air fryer until the door is securely closed again. The internal light will always illuminate while the door is open.











4.  Rotation button: select this button when cooking with the rotisserie fork set or rolling cage. This rotation mode can be used with any cooking preset program. The rotation icon will blink while it is in use.

5.  Time control icon: press the + or – buttons next to this icon to increase or decrease the cooking time.
- The cooking time range is 1 – 60 minutes, set in 1-minute increments, on all of the cooking preset programs except for dehydrate.
  - The time range on dehydrate mode is 2 hours – 24 hours, set in 30-minute increments.
  - The + and – buttons for the time control can be pressed during a cooking process to adjust the cooking time.

6.  Temperature control icon: press the + or – buttons next to this icon to increase or decrease the cooking temperature.
- The temperature can be set in 5-degree increments.
  - The temperature range is 65°C – 200°C on all of the cooking preset programs except for dehydrate and defrost.
  - The temperature range on dehydrate mode is 30°C – 80°C.
  - The temperature range on defrost mode is 40°C – 70°C.

**Note:** During the setting process, if no button is pressed within a 1-minute period, the screen display will go off and only the power button will remain on. Pressing the power button will turn the screen on again.

#### PRESET COOKING TIMES AND TEMPERATURES:

Icons	Preset	Time	Temperature
	Chips	18 minutes	200°C
	Beef	20 minutes	200°C
	Prawn	12 minutes	160°C
	Bake	30 minutes	160°C
	Chicken pieces	25 minutes	180°C
	Steak	12 minutes	200°C
	Fish	13 minutes	200°C
	Whole chicken	40 minutes	190°C
	Dehydrator	4 hours	70°C
	Defrost	12 minutes	70°C

### COOKING WITH THE AIR FRYER:

1. Place the food onto a mesh rack, on the rotisserie fork set or into the rolling cage.
2. Place the food and chosen accessory into the air fryer and close the door. Plug the power cord into a 220-240V dedicated outlet.
3. Press the power button once.
4. Select a preset cooking program or manually set the cooking time and temperature.
5. Once the desired cooking time and temperature have been selected, press the power button to begin the cooking process.

### MANUALLY SETTING THE TIME AND TEMPERATURE:

1. Press one of the preset cooking program icons.
2. Press the + or – buttons to adjust the time and / or temperature.
3. Once the desired cooking time and temperature are shown on the screen, press the power button to begin the cooking process.

### COOKING CHART:

These cooking times are a guide only. They could vary depending on quantity, initial temperature, and weight.

Food	Time	Temperature	Additional information
Thin frozen chips	15 – 20 mins	200°C	
Thick frozen chips	20 – 25 mins	200°C	
Homemade chips	15 – 20 mins	200°C	Add ½ tablespoon oil
Homemade potato wedges	18 – 22 mins	180°C	Add ½ tablespoon oil
Homemade potato cubes	12 – 18 mins	180°C	Add ½ tablespoon oil
Hash browns	15 – 18 mins	180°C	
Potato gratin	25 – 30 mins	200°C	
Steak	10 – 15 mins	180°C	
Hamburger	10 – 15 mins	180°C	
Pork chops	10 – 15 mins	180°C	
Sausage roll	13 – 15 mins	200°C	
Chicken drumsticks	25 – 30 mins	180°C	
Chicken breast	15 – 20 mins	180°C	
Spring rolls	8 – 10 mins	200°C	Use oven-ready
Frozen chicken nuggets	10 – 15 mins	200°C	Use oven-ready
Fish fingers	6 – 10 mins	200°C	Use oven-ready
Mozzarella sticks	8 – 10 mins	180°C	Use oven-ready

Food	Time	Temperature	Additional information
Stuffed vegetables	10 mins	160°C	
Cake	20 – 25 mins	160°C	Use a baking dish
Quiche	20 – 22 mins	180°C	Use a baking dish
Muffins	15 – 18 mins	200°C	Use a baking dish
Sweet snacks	20 mins	160°C	Use a baking dish
Frozen onion rings	15 mins	200°C	

*\*Baking dish not included, use your own oven safe bake ware.*

### **MAKING HOME MADE CHIPS:**

For the best results, we advise to use frozen pre-baked chips. If you want to make home-made chips, follow the steps below:

1. Peel the potatoes and cut them into sticks.
2. Soak the potato sticks in a bowl of water for at least 30 minutes, take them out and dry them with kitchen paper.
3. Pour ½ tablespoon of olive oil in a bowl, put the sticks on top and mix until the sticks are coated with the olive oil.
4. Remove the sticks from the bowl and put the sticks into the rolling cage.
5. Fit the rolling cage inside the air fryer.
6. Cook the chips for 20 – 25 minutes at 200°C.

### **TIPS:**

- Foods that are smaller in size usually require a slightly shorter cooking time than larger ones.
- Large quantities of food only require a slightly longer cooking time than smaller quantities.
- Flipping or turning smaller sized foods halfway through the cooking process ensures that all the pieces are evenly fried.
- Misting a bit of vegetable or olive oil on fresh potatoes is suggested for a crispier result. When adding a little oil, do so just before cooking.
- Snacks normally cooked in an oven can also be cooked in the air fryer.
- Use premade dough to prepare filled snacks quickly and easily. Premade dough also requires a shorter cooking time than homemade dough.

## **TROUBLESHOOTING:**

<b>Problem</b>	<b>Possible cause</b>	<b>Solution</b>
The air fryer does not work.	The appliance is not plugged into the mains power.	Put the mains plug in an earthed wall socket.
The food is not done.	There is too much food inside the rolling cage.	Use smaller batches for more even cooking.
	The set temperature is too low.	Increase the cooking temperature.
	The preparation time is too short.	Increase the cooking time.
The food is unevenly fried in the air fryer.	Certain types of food need to be flipped over during the cooking process.	Flip the ingredients during cooking.
Fried snacks are not crispy when they come out of the air fryer.	You used a type of food that is meant to be prepared in a traditional deep fryer.	Use oven snacks or lightly brush some oil onto the snacks for a crispier result.
Chips are not cooked evenly.	You did not soak the potato sticks properly before cooking.	Soak the potato sticks in a bowl of water for at least 30 minutes; take them out and dry them with kitchen paper.
	You did not use the right potato type.	Use fresh potatoes and make sure they stay firm during frying.
Fresh potato chips are not crispy when they come out of the air fryer.	The crispiness of the chips depends on the amount of oil and water in the potato sticks.	Make sure you dry the potato sticks properly before you coat them with oil. Cut the potato into thinner sticks for a crispier result. Add slightly more oil for a crispier result.
White smoke comes out of the appliance.	You are preparing greasy ingredients.	Pay attention that the temperature is under 180°C when you cook greasy food in the air fryer.
	There is excess oil inside the air fryer.	Wipe down the inside of the air fryer to remove excessive oil and check the drip tray.
	The accessories have excess grease residue from previous cooking.	Clean each accessory after use.

## **FREQUENTLY ASKED QUESTIONS:**

### ***1. Can I prepare foods other than fried dishes with my air fryer oven?***

You can prepare a variety of dishes including steaks, chops, burgers, and baked goods.

### ***2. Is the air fryer oven good for making or reheating soups and sauces?***

Never cook or reheat liquids in the air fryer oven.

### ***3. What do I do if the air fryer oven shuts down while cooking?***

As a safety feature, the air fryer oven has an automatic shut-off device that prevents damage from overheating. Unplug and allow the appliance to cool down completely. Plug back in and restart with the power button.

### ***4. Does the air fryer oven need time to heat up?***

Preheating is needed when you are cooking from a cold start, add 3 minutes to the cooking time to compensate for this.

### ***5. Is it possible to shut off the air fryer oven at any time?***

Press the power button once or open the door to pause the cooking process.

### ***6. Can I check the food during the cooking process?***

You can open the door to pause the cooking process and flip the food on the mesh racks, if needed, to ensure even cooking. The cooking time and temperature will resume where it left off, once the door is securely closed again.

### ***7. Is the air fryer oven dishwasher safe?***

Only the accessories are dishwasher safe. The appliance itself containing the heating coil and electronics should never be submersed in liquid of any kind or cleaned with anything more than a hot, moist cloth or nonabrasive sponge, with a small amount of mild detergent.

### ***8. What happens if the air fryer oven still does not work after I have tried all the troubleshooting suggestions?***

Please contact our customer service team.

## **CLEANING AND MAINTENANCE:**

**Note:** Unplug the appliance and allow it to cool down completely before handling, cleaning or storing.

- Wash all the accessories in warm soapy water after use.
- All the included accessories are also dishwasher safe.
- The removeable door is not dishwasher safe.
- The inside of the air fryer can be cleaned with hot water, a mild detergent and a non-abrasive sponge.
- Wipe the outer housing body with a soft, damp cloth. Do not use detergents or cleaners on the outside of the appliance.



- To clean the removeable door, open the door to a 30° angle and gently remove it by sliding it out and upwards. The door can be washed in warm soapy water.
- Do not immerse the power cord, plug or the housing body in water or any other liquids as it may result in damage, fire, electric shock or injury.

**STORING:**

Allow the appliance to cool down completely before storing. Store the appliance in an upright position in a dry location. Do not place any heavy items on top of the appliance during storage as this may result in possible damage to the appliance.

**TECHNICAL SPECIFICATIONS:**

Voltage:	220~240V
Power:	1800W
Frequency:	50-60 Hz
Temperature range:	65°C – 200°C
Time setting range:	1 – 60 minutes
Dehydrate temperature range:	30°C – 80°C
Dehydrate time setting range:	2 – 24 hours
Defrost temperature range:	40°C – 70°C
Defrost time setting range	1 – 60 minutes
Capacity:	12 litre inner chamber

**LENOXX**

[www.lenoxx.com.au](http://www.lenoxx.com.au)

 1300 666 848

 LenoxxElectronics

 LenoxxElectronics

 @LenoxxAustralia