



TP200

Rebound Fitness Trampoline



MODEL: TP200

BATCH: PR4462

THIS APPLIANCE IS INTENDED FOR HOUSEHOLD USE ONLY.

PLEASE READ AND RETAIN INSTRUCTIONS FOR FUTURE REFERENCE.

The illustrations used in the manual are to illustrate the operation method and structure of the product. Where there is a small difference between the physical item and the illustrations, please take the physical as the standard.



WARNING IMPORTANT – PLEASE READ!

IMPORTANT - It is essential that the intended site for this trampoline is completely flat and level. If the surface is un-level this will cause movement in the frame and could cause stress on the joined sections.

The recommended safe use area is a minimum of 2500cm (2.5 meters) beyond the trampoline on all sides. There must be no obstacles within the use area.

- Ensure the trampoline has been assembled correctly, as per the instructions in the manual.
- This product is **NOT** recommended for use by children under **8 YEARS OF AGE**.
- **DO NOT** exceed the recommended **MAXIMUM WEIGHT** limit of **110 KGS**.
- **DO NOT** allow more than one person on the trampoline at a time.
- **DO NOT** wear glasses or helmets when using the trampoline.
- **DO NOT** fall or bounce on your knees, this can cause injury.
- **DO NOT** use the trampoline outdoors. It is suitable for indoor household use only. This product is not suitable to be used for commercial purposes or in a commercial environment, e.g.: public gymnasium.
- **DO NOT** somersault – this can cause serious injury.
- **DO NOT** allow other persons to go under, sit, stand or lie on the frame pads whilst the trampoline is in use.
- **DO NOT** use the trampoline when under the influence of alcohol, drugs or medication which may impair the jumper's judgement.
- **ALWAYS** wear socks when using the trampoline.
- **ALWAYS** remove jewelry before using the trampoline.
- **ALWAYS** jump in the middle of the trampoline bed.
- **ALWAYS** follow the safety warnings stated with your trampoline.
- **NEVER** wear footwear (e.g., shoes) when using the trampoline.
- Children **MUST NEVER** use the trampoline unless supervised by a responsible adult with knowledge of trampoline use.
- Before trampolining, inspect and replace any worn, defective or missing parts.
- Mount and dismount the trampoline with care as injury may result.

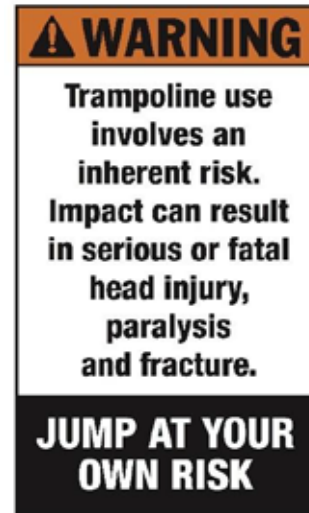

Care & Use

- This trampoline must be assembled by an adult. It must be erected exactly as detailed in the assembly instructions. Please ensure children under the age of 36 months do not play with or are given any part of this trampoline when being assembled or when complete as it contains small parts which may pose a choking hazard.
- Please take care during assembly as the manufacturing process can sometimes result in the occasional sharp edge and small pieces of waste metalwork. The use of gloves to protect your hands from pinch points during assembly is also recommended. Should there be any missing parts, the trampoline must not be used until replacement parts have been fitted.
- Your trampoline must be placed on a flat and level surface which is well-lit. It is important not to place or store anything under your trampoline.

Usage

- This trampoline is designed and made for household use only within the recommended weight limit (110kg). This trampoline is not intended for use outside of these guidelines. The user must remove footwear (shoes) before use. The user must wear socks when using the trampoline. Misuse can result in injury. Inspect the trampoline before use and always replace worn, defective or missing parts. The pads should always be fitted.

Supervision

- Children must always be supervised while they are playing on the trampoline and must be instructed not to use the trampoline in an inappropriate or hazardous manner.

Remember!

- Trampolines are **rebounding** devices which **propel** the user to **unaccustomed** heights, and into a variety of body movements. Rebounding from the trampoline, striking the frame or Spherical Elastic buckles, or improperly landing on the trampoline mat (bed) may cause injury.

Warning!

- Do not land on head or neck. Paralysis or death can result even if you land in the middle of the trampoline mat (bed). To reduce the chance of landing on your head or neck, do not do somersaults (flips).
- **IMPORTANT** - You must not use the trampoline if you have a medical history of neck or back injuries or a mental or physical condition – these could cause injury.
- For safety reasons, only one person at a time should use the trampoline. Multiple jumpers increase the chances of loss of control, collision, and falling off. This can result in broken head, neck, back or leg.
- No modification should be carried out to the trampoline or any of its components. Any modification could lead to damage to the product or to personal injury.
- We recommend that the user does not wear loose-fitting clothing or jewelry that may catch or snag during play. Ensure that younger children do not crawl underneath the trampoline and keep the area around and underneath free from all solid objects at all times.

Jumper's Role in Preventing Accidents

- Education on the part of the user is a must for safety. Users must first learn a low controlled bounce and the basic landing positions and combinations before proceeding to intermediate skills. Jumpers must understand why they have to master "control" before they can start thinking about other moves. Understanding the proper progression of skills in jumping on a trampoline must be the first lesson.

Supervisor's Role in Preventing Accidents

- It is the responsibility of the supervisor(s) of trampoline users to provide knowledgeable and mature supervision. They need to know and enforce all the rules and warnings set forth in this manual in order to minimize the likelihood of accidents and injuries and to inform users of these rules. During periods of time when supervision is unavailable or inadequate, this may require that the trampoline be disassembled, placed in a secure area, or otherwise secured against unauthorized use. It is the responsibility of the supervisor(s) to be sure that the users are fully aware of the safety information included in this instruction manual.

Placement

IMPORTANT - It is essential that the intended site for this trampoline is completely flat and level. If the surface is un-level this will cause movement in the frame and could cause stress on the joined sections.

The recommended safe use area is a minimum of 2500cm (2.5 meters) beyond the trampoline on all sides. There must be no obstacles within the use area.

- Ensure appropriate clearance from any ceilings, ceiling fixtures or hard surfaces. In terms of horizontal clearance, ensure that potentially hazardous objects and conditions include but not limited to: electric cables, furniture, appliances, lighting, walls, shelving, anything overhead etc.) and no potentially hazardous conditions exist nearby (including but not limited to: stairwells, pools/hot tubs, any bodies of water, uneven or drop-off ground levels, etc.) For safe use of the trampoline, please be aware of the following when selecting a workout location for your trampoline:
 - Make sure the trampoline is placed on a stable and level surface.
 - The area is well lit.
 - There are no obstructions above, beneath, or around the trampoline. If you do not follow these guidelines, the user acknowledges responsibility for the increased risk of serious injury.

How To Use Your Trampoline

- Always bounce at the centre of the bed. Bouncing near the edge of the bed can lead to injury and can also stretch the Spherical Elastic buckles. The frame pad is not designed nor intended to support the weight of the trampoline user. Do not step or jump directly onto the frame pad.
- Avoid bouncing too high. Stay low until you can control your bounce and land consistently in the middle of the bed.
- To regain control and stop your jump, bend your knees quickly when you land.
- Do not use the trampoline when under the influence of alcohol or drugs.
- Extended bouncing exposes an over tired user to an increased risk of injury.
- Jumping off the trampoline to the ground or any other surface may result in injury. Jumping onto the trampoline from a roof, deck, or other object also represents a risk of injury. Users should step onto the trampoline by placing stepping onto the mat, not the frame pad. Users should always place their hands on the handlebar support while mounting or dismounting. To dismount, jumpers should walk to the side of the mat, place one hand on handlebar support, then step from the mat to the ground.

Injury may result from hitting the frame or falling through the Spherical Elastic buckles while jumping or getting on or off the trampoline. Stay in the center of the trampoline mat when jumping. **BE SURE TO KEEP THE FRAME PAD IN PLACE TO COVER THE FRAME AT ALL TIMES.** The frame pad is not designed nor intended to support the weight of the trampoline user. Do not step or jump directly onto the frame pad.

ASSEMBLY: (No tools required)

Step 1 - Attach the Frame Pad to the trampoline

> Remove all rubber caps on the leg sockets and wrap Frame Pad around the trampoline frame (# 2).

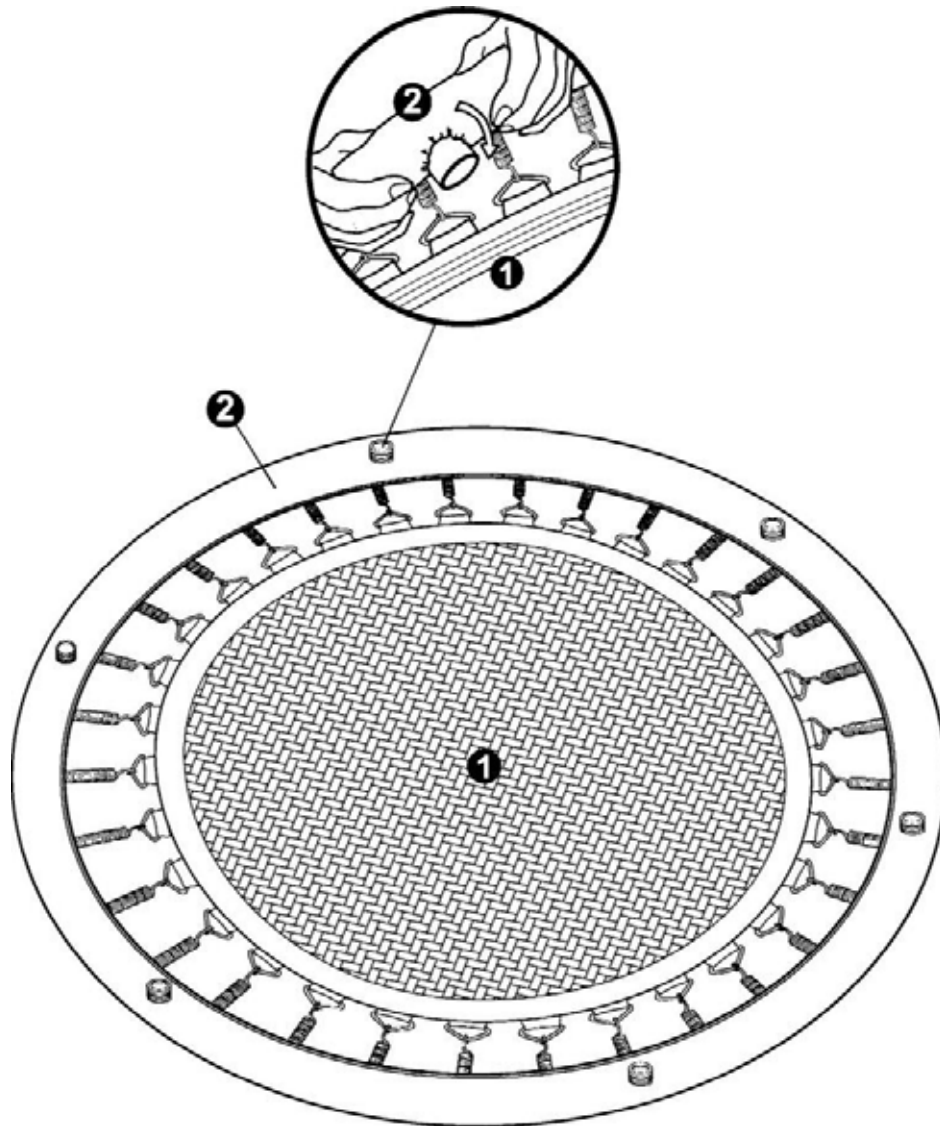

Step 2 -Attach the Legs to the Trampoline

- > Tightly screw the Legs onto the leg sockets (#3) of the trampoline frame.
- > Remove TWO Legs' Caps (#8) from the front of the trampoline. These will be needed to install the handlebar in the next step.

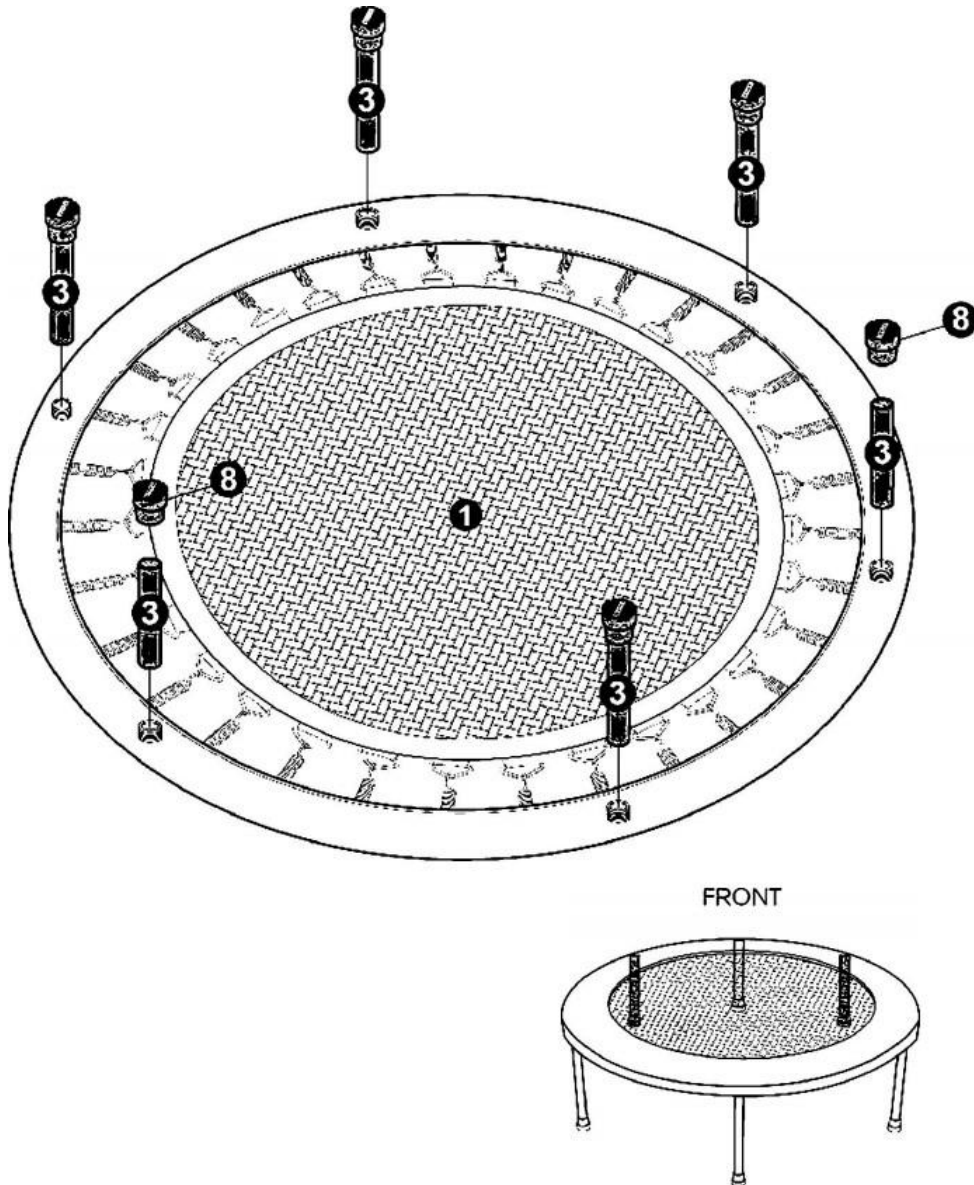

Step 3 - Assemble Handlebar

> Lift the trampoline to its standing position. Attach Handrail Legs (#4A and #4B) to the two front legs without the caps, screw a little with TriangleAdjustment Knob (#B), then place Leg Cap (#8) onto the handrail legs.

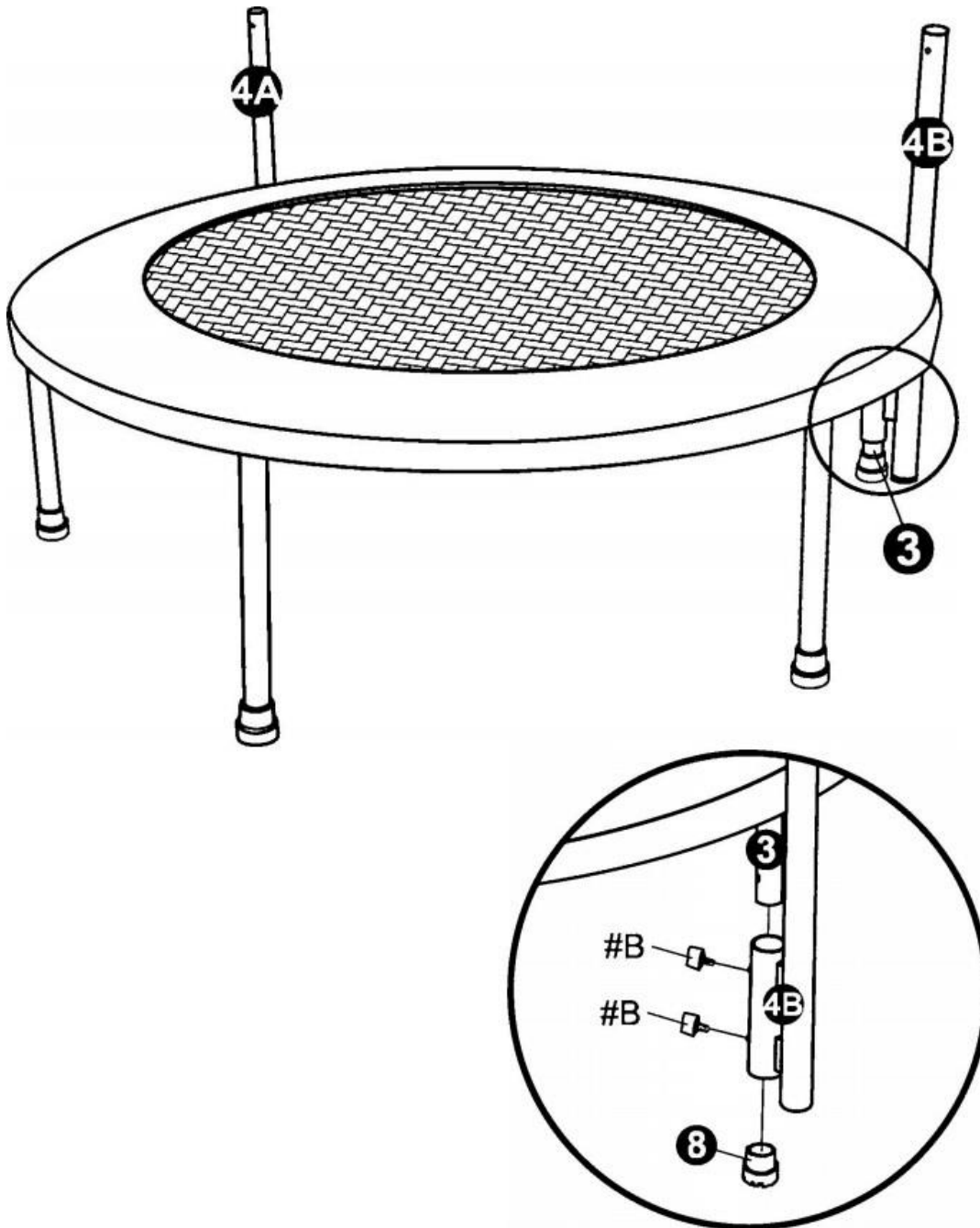

Step 4 - Assemble Handlebar Support

- > Attach Handrail Support (#6A and #6B) to each side of Handlebar (#5).
- > Triangle Adjustment Knobs (#B) are secured tightly on each side.
- > Connect the assembled handlebar to Handrail Leg Supports (#4A and #4B) and secure tightly with Adjustment Knob (#A) at the appropriate height level.



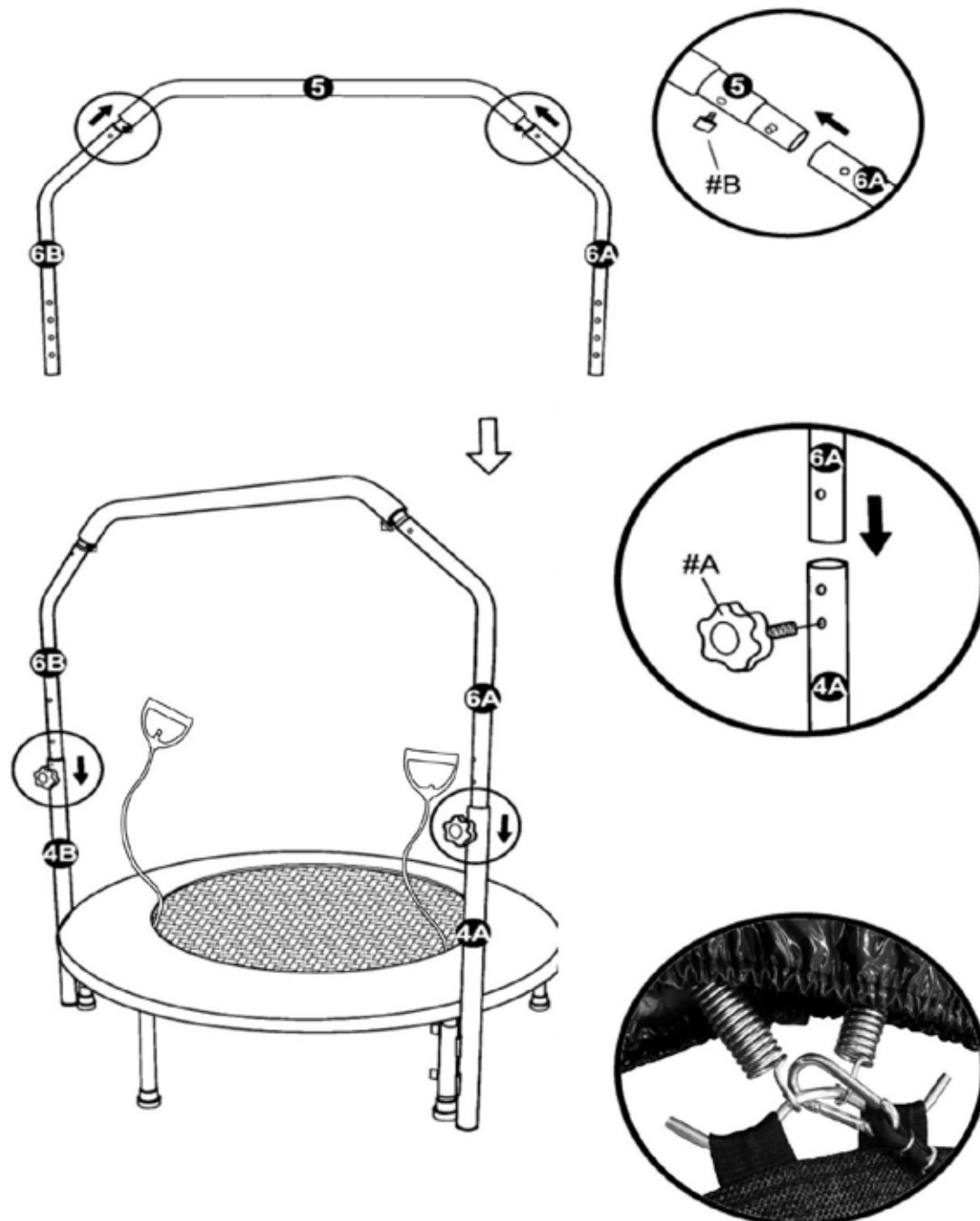



!!!Attention!!!: All the Legs (#3), Leg Caps (#8) and Knobs must be screwed on tightly, and Legs (#3) must be flat on ground before use.

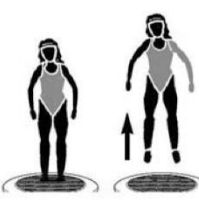
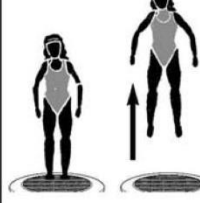

EXERCISES

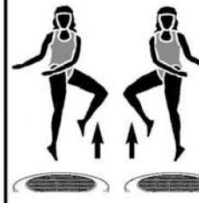
IMPORTANT

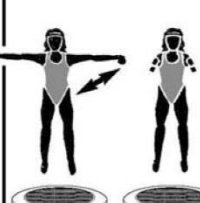
Always warm up thoroughly before starting your workout.
Do at least five minutes of stretching to help prevent muscle pulls and strains.

 <p>1. Low Bounce Bounce upwards only a few inches. Keep the feet 12 to 18 inches apart and bend the knees slightly on take-off and landing. Perform 1 to 3 minutes</p>	 <p>2. High Bounce Bounce upward from 12 to 18 inches. Start with the feet together with toes pointed downward at the top of each bounce. Spread the feet as you land off each bounce. Perform 1 to 3 minutes</p>	 <p>3. Jogging Jog in place. Lift the knees high and swing arms vigorously. The higher you lift your knees, the better the exercise is for the abdomen. Perform 1 to 10 minutes</p>	 <p>4. Straddle Hops Start with feet together and arms at the sides. Leap upwards, bringing both arms overhead and spread the feet sideward about 24 inches. On the return bounce, bring the arms to the side and feet together. Perform 10 to 50 repetitions</p>	 <p>5. Twister Leap upward while twisting the arms, hips and upper body turning right and the knees twisting left. On the rebound, twist the opposite way. Perform 10 to 50 repetitions</p>
 <p>6. High Kick Low Kick Leap slightly and kick high with one leg while keeping the hands on the hips. On the rebound do a low kick (about half as high) with the other leg. Continue to alternate high and low kicks. Perform 1 to 5 minutes</p>	 <p>7. Jog with Dumbbells Hold a light pair of dumbbells (3.3 to 5.5 lbs) in your hands. Jog in place lifting the knees high and moving the arms in rhythm as you jog. Perform 30 secs to 3 minutes</p>	 <p>8. Side & Forward Laterals Hold the dumbbells with both arms straight down by the side. Bounce on both feet and raise the dumbbells sideward. On the next bounce, raise the dumbbells forward. Perform 10 to 25 repetitions</p>	 <p>9. Ankle & Wrist Weights For a more strenuous workout, try using ankle and wrist weights on the exercises shown here.</p>	

Time or count your exercises and don't over extend yourself. Start with the minimum times or repetitions and gradually increase to the maximum recommended.

If you combine various exercises and perform them to music, you will enjoy your workouts even more!

CARE AND MAINTENANCE

- **FRAME** Do not sit or stand on the frame or the frame pads while the trampoline is in use as this restricts the frame's natural reflex action. If surface rust appears it should be removed with either a wire brush or coarse sandpaper, and the area treated with a non-toxic paint.
- **FRAME PADS** Frame pads are there to protect the user from any fall or landing on the Spherical Elastic buckles and frame. On no account should people be permitted to sit or stand on them when the trampoline is in use. You should also make sure that smaller users do not use the inside edges of the pads as a "handle" when getting up on to the trampoline.
- **THE MAT** The mat (bed) will, over the years, be gradually weakened by the effects of ultraviolet radiation. Therefore, the more it can be protected from direct sunlight the longer it will last. A little mold or mildew should not harm the mat. Do make sure that shoes are removed before bouncing and ensure that any other sharp objects such as belt buckles, brooches and jewelry are removed too.
- **THE SPHERICAL ELASTIC BUCKLES** Do not stand on the Spherical Elastic buckles whilst the trampoline is in use. Try not to bounce on to the Spherical Elastic buckles. They are not designed for this sort of stress and can become stretched, misshapen and weakened. If you find you have any damage Spherical Elastic buckles, it is important to replace them as soon as possible to avoid damage to the trampoline mat and avoid overloading and therefore damaging the remaining good Spherical Elastic buckles.

LENOXX

www.lenoxx.com.au

 1300 666 848

 LenoxxElectronics

 LenoxxElectronics

 @LenoxxAustralia